

# Series 4401 Installation Guide for 1/8" Cable Adjust-A-Body<sup>®</sup> Hanger Bolt with Pull-Lock<sup>™</sup> Fitting

## Materials/tools required \_\_\_\_\_

- \* **Cable Gripping Pliers** — (50TCG1)  
Used to grip the cable while tensioning the end fittings without damaging the cable.  
[OPTION: Use a piece of rubber hose with vice grips around the cable to prevent scarring.]
- \* **Cable Cutter 1/8"** — (82T07)
- \* **(2) 7/16" Open-end Wrenches**
- \* **1/4" Open-end Wrench** or **Hanger Bolt Driver** — (20TLBDN4N)  
Use with a 5/8" socket to install hanger bolts
- \* **Drill**
- \* **Drill Bits:**
  - **29/64"**
  - **5/32"** (if there are intermediate posts between terminating end posts or where the length of the Pull-Lock<sup>™</sup> fitting you are using is less than the thickness of the end post)
  - **15/16"** (if you wish to counterbore the wood end post for the Pull-Lock<sup>™</sup> fitting to recess the 11HW14 washer)



- **15/64"** for hanger bolt pilot hole (**1/4"** if installing in extremely hard wood)

- \* **Cut Off Wheel Kit** — (11TCUTKIT))

## Drill posts \_\_\_\_\_

**Terminating (end) post for Adjust-A-Body<sup>®</sup> with Hanger Bolt tensioner** — Drill a 15/64" hanger bolt pilot hole (1/4" if installing in extremely hard wood).

**Terminating (end) post for Pull-Lock<sup>™</sup> fittings** — Drill a 29/64" hole from the back side of the end posts where each cable will be installed. For a 1-1/2" or less square end post, drill the hole completely through the post. For posts greater than 1-1/2" thick, drill a 5/32" pilot

hole completely through the post, then drill a 29/64" hole only through the back surface of the end post (in the case of a wood post, to a depth a little greater than the length of the Pull-Lock<sup>™</sup> fitting) but not completely through the post.

**Intermediate post or other element through which the cable will pass between the end posts** — Drill 5/32" diameter holes lined up with the holes in the end post through which the cable will pass between end posts.

## Install Adjust-A-Body® Hanger Bolt tensioner

1. Drill 15/64" pilot holes (1/4" if installing in extremely hard wood) into one terminating end post where you will be installing the tensioner.
2. Screw the hanger bolts into the holes in the terminating end post.
3. Screw the lock nut onto the machine threads.
4. Slide the body onto the cable, threaded end first, all the way to the end of the cable.
5. Turn the body by hand, onto the threads at least 6 full turns. Do not tension the cables at this point.

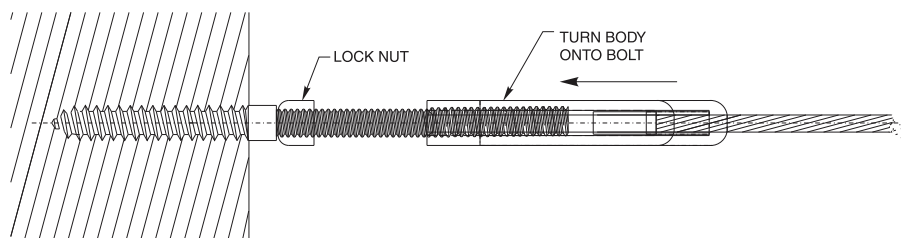

**String the cable through the holes drilled in your intermediate posts (or other elements through which the cable passes between end posts) and through the end post where you will be installing the Pull-Lock™ fitting.**

See illustration — Post A is the end post to which the tensioner is attached; Post B is the end post to which the Pull-Lock™ fitting is to be attached.

Post A



Adjust-A-Body  
with Hanger Bolt



Post B



Pull-Lock™  
Fitting

## Install Pull-Lock™ fittings

1. With the cable strung through the end post, cut the cable with a cable cutter (82T07), leaving enough cable extending out the back side of the post to be able to grasp the cable firmly with your hand (6" or more).
2. Slide the washer (black plastic for metal posts, 11HW14 stainless steel for wood posts) over the body of the Pull-Lock™ fitting.

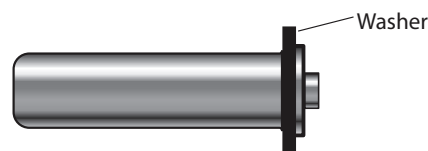
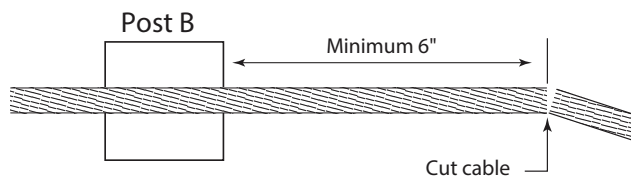

- Push the cable into the hole in the front of the Pull-Lock™ fitting, and pull the cable through the fitting. Twist the cable in the right-hand direction (with the lay of the cable) as you push it through the fitting. Then slide the fitting along the cable and up to the back side of the post.

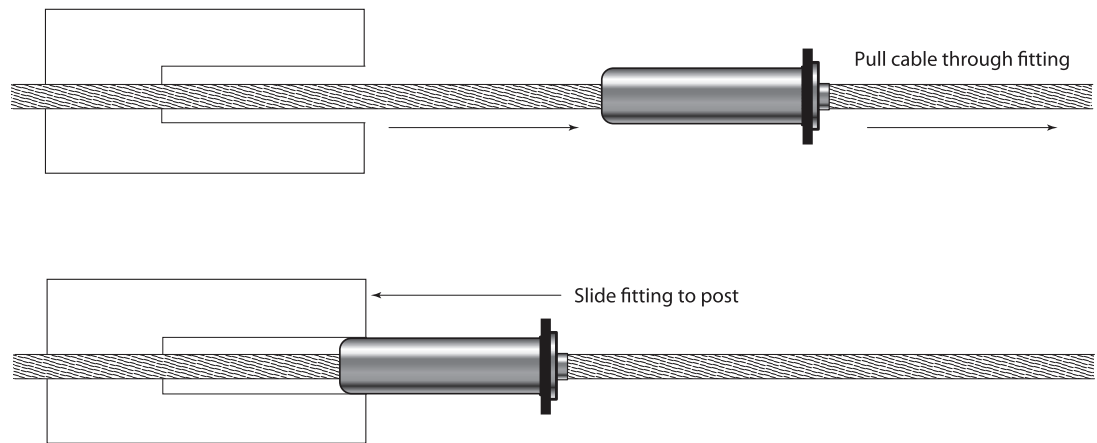

- Hold the cable with one hand and slide the Pull-Lock™ fitting into the hole in the post. Press the back of the fitting to hold it securely in the post and pull the cable through the fitting until it is as tight as you can make it.

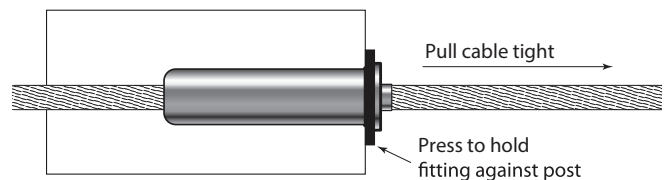

- Pull the cable to set the gripping action of the Pull-Lock™ fitting.

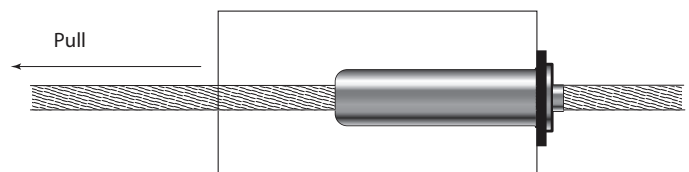

- Tension the cables:  
After all the cables have been installed in both end posts, with a 7/16" open-end wrench, tension the cables on the other end to approximately 150 lbs. per cable, by holding the cable with the Cable Gripping Pliers (50TCG1) closely behind the body as you turn the body onto the threads with the open-end wrench.

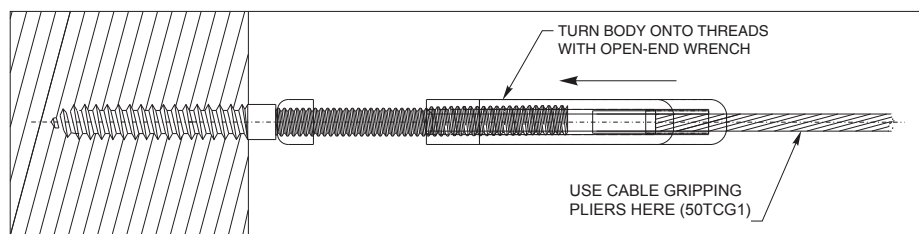

Tension in sequence,  
beginning with the  
outside cables and  
moving from side to  
side toward the centre

7. With (2) 7/16" open-end wrenches, tighten the lock nut against the body of the fitting.

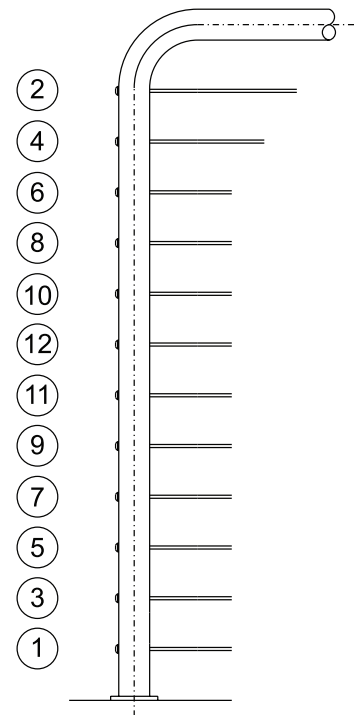
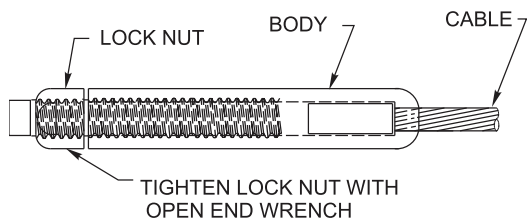

RECOMMENDED TENSIONING SEQUENCE

8. Cut the cable flush with the hole in the back of the Pull-Lock™ fitting, using a cut-off wheel (11TCUTKIT).

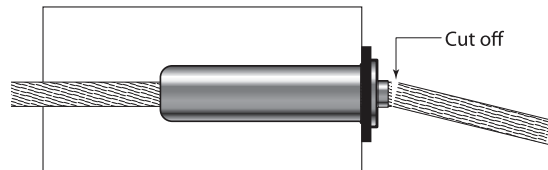

9. Press the cap onto the lip of the Pull-Lock™ fitting.

