

LPF-3/4

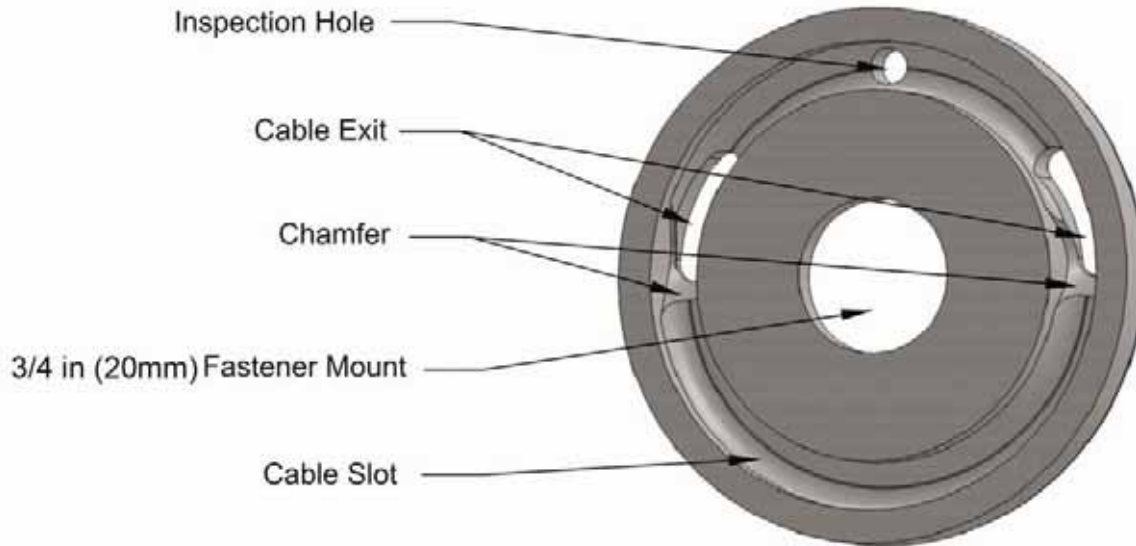

The LPF-3/4 is specifically designed to reduce the prying effect on fasteners. The cable is nested in the groove provided, and exits through two chamfered slots (to prevent damage to the outer fibers of the cable). An inspection hole is provided to ensure that the cable is placed in the correct position within the groove. The LPF has the lowest prying factor yet to be achieved. The cable mount will accept Gold, Orange, and Green cable.

Prying Factor		
Orientation 1		
Angle A	Angle B	Angle C
1.651	0.857	0.434

Prying Factor		
Orientation 2		
Angle D	Angle E	Angle F
0.673	0.818	0.895

Prying Factor		
Orientation 3		
Angle G	Angle H	Angle I
0.500	0.354	0.289

UL Rated Load (lbs-f)	ICC-ES Breaking Strength (lbf)
1,900	1,700



LPF Installation

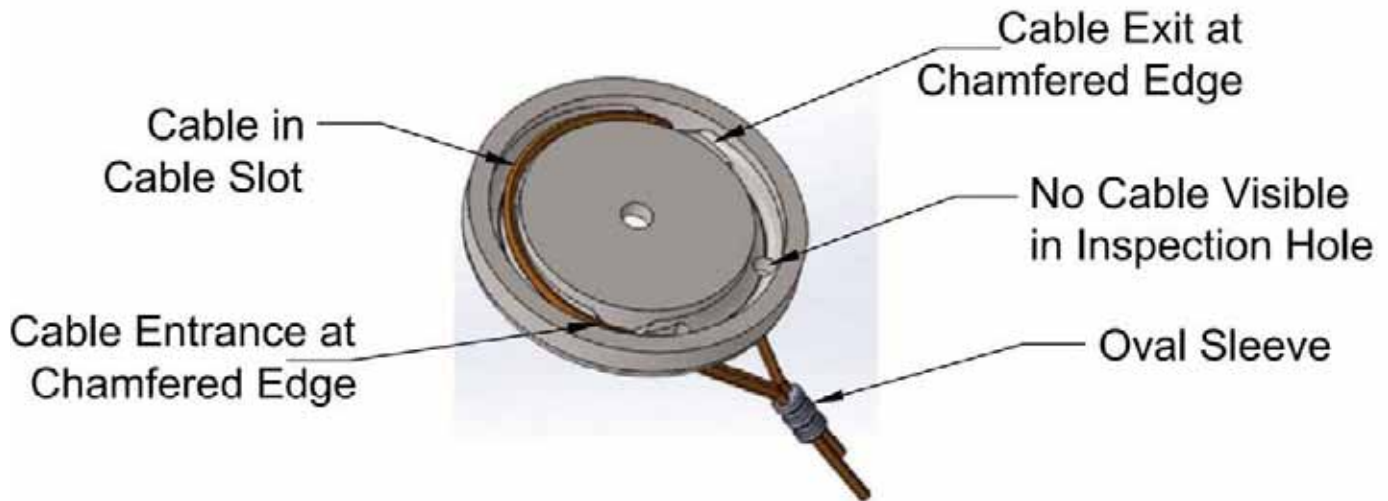

The Low-Pry Fitting (LPF), due to its design, offers a low prying effect. The cable is inserted into the slot provided, at the chamfered edge, through the cable slot and out the cable exit. The cable is then secured with the proper size oval sleeve. To ensure that the cable is properly installed, no cable should be visible through the inspection hole (opposite the proper cable slot). The LPF should be mounted with the inspection hole pointed in the direction of the brace. The cable mount will accept Gold, Orange, and Green cable.

INSTRUCTIONS

Load: Perpendicular to Structural Member

Angles: A (30°), B (45°), and C (60°)

Material: Through-bolts in Sawn Lumber or Glue-Laminated Timbers

Table: 18.5.12.2 (L)

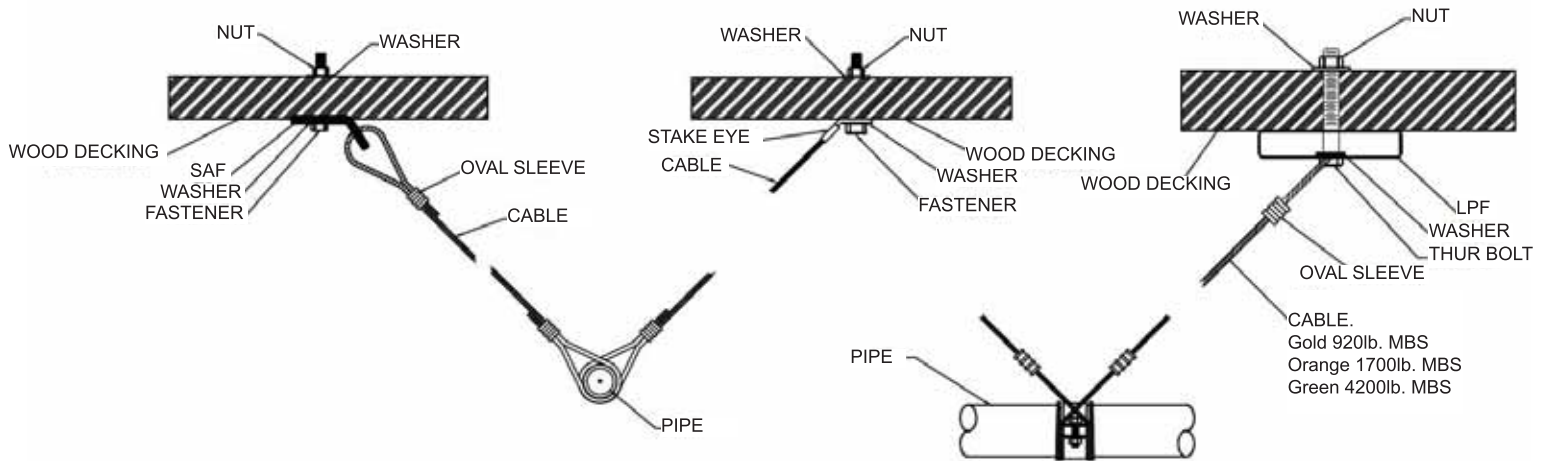

Bolt Length	1/2" Bolt Diameter			5/8" Bolt Diameter			3/4" Bolt Diameter		
	30° - 44°	45° - 59°	60° - 90°	30° - 44°	45° - 59°	60° - 90°	30° - 44°	45° - 59°	60° - 90°
1-1/2"	115 lbs.	165 lbs.	200 lbs.	135 lbs.	190 lbs.	235 lbs.	155 lbs.	220 lbs.	270 lbs.
2-1/2"	140 lbs.	200 lbs.	240 lbs.	160 lbs.	225 lbs.	280 lbs.	180 lbs.	255 lbs.	310 lbs.
3-1/2"	175 lbs.	250 lbs.	305 lbs.	200 lbs.	285 lbs.	345 lbs.	220 lbs.	310 lbs.	380 lbs.
5-1/2"	N/A	N/A	N/A	280 lbs.	395 lbs.	485 lbs.	310 lbs.	440 lbs.	535 lbs.

Above listed values based on wood with a specific gravity of 0.35. Values for other woods can be obtained by multiplying above values by factors listed in Figure 1.

Figure 1

Specific Gravity of Wood	Multiplier
0.36 - 0.49	1.17
0.50 - 0.65	1.25
0.66 - 0.73	1.50



NFPA-13 2019

Load: Perpendicular to Structural Member

Angles: A (30°), B (45°), and C (60°)

Material: Lag Screw and Lag Bolts in Wood

Table: 18.5.12.2 (M)

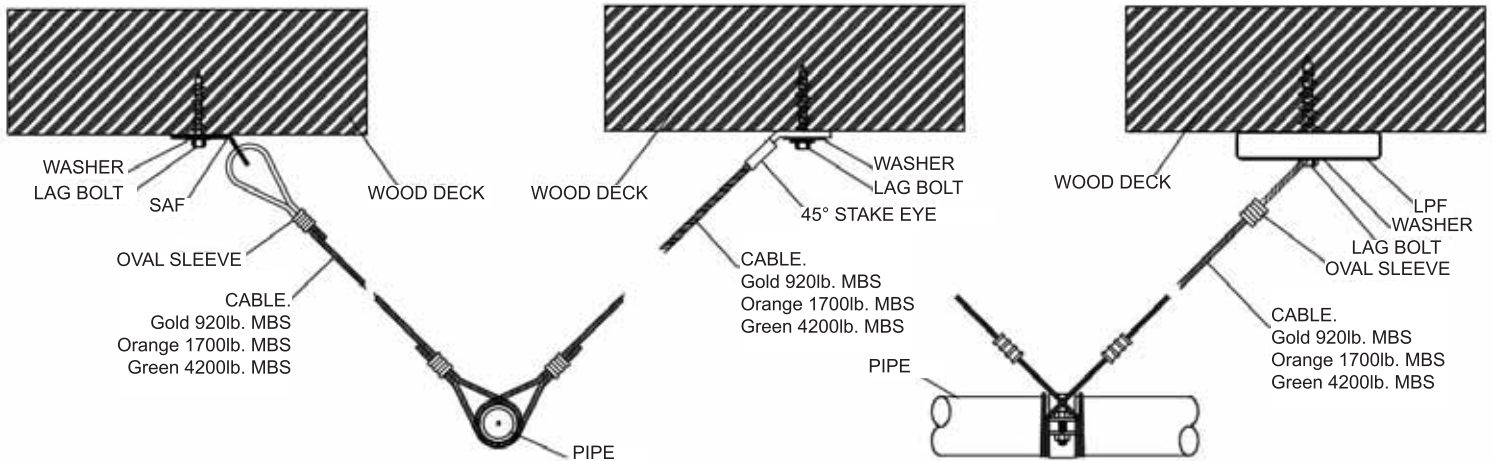

Lag Length	3/8" Lag Diameter			1/2" Lag Diameter			5/8" Lag Diameter		
	30° - 44°	45° - 59°	60° - 90°	30° - 44°	45° - 59°	60° - 90°	30° - 44°	45° - 59°	60° - 90°
3-1/2"	165 lbs.	190 lbs.	200 lbs.						
4-1/2"	180 lbs.	200 lbs.	200 lbs.	300 lbs.	355 lbs.	380 lbs.			
5-1/2"	190 lbs.	200 lbs.	200 lbs.	320 lbs.	370 lbs.	380 lbs.	435 lbs.	525 lbs.	555 lbs.
6-1/2"	195 lbs.	205 lbs.	200 lbs.	340 lbs.	375 lbs.	380 lbs.	465 lbs.	540 lbs.	555 lbs.

Above listed values based on wood with a specific gravity of 0.35. Values for other woods can be obtained by multiplying above values by factors listed in Figure 1.

Figure 1

Specific Gravity of Wood	Multiplier
0.36 - 0.49	1.17
0.50 - 0.65	1.25
0.66 - 0.73	1.50



NFPA-13 2019

INSTRUCTIONS

Load: Perpendicular to Structural Member

Angles: A (30°), B (45°), and C (60°)

Material: Wedge anchors in 3,000 PSI (207 bar) Lightweight Cracked Concrete on Metal Decking

Table: 18.5.12.2 (A)

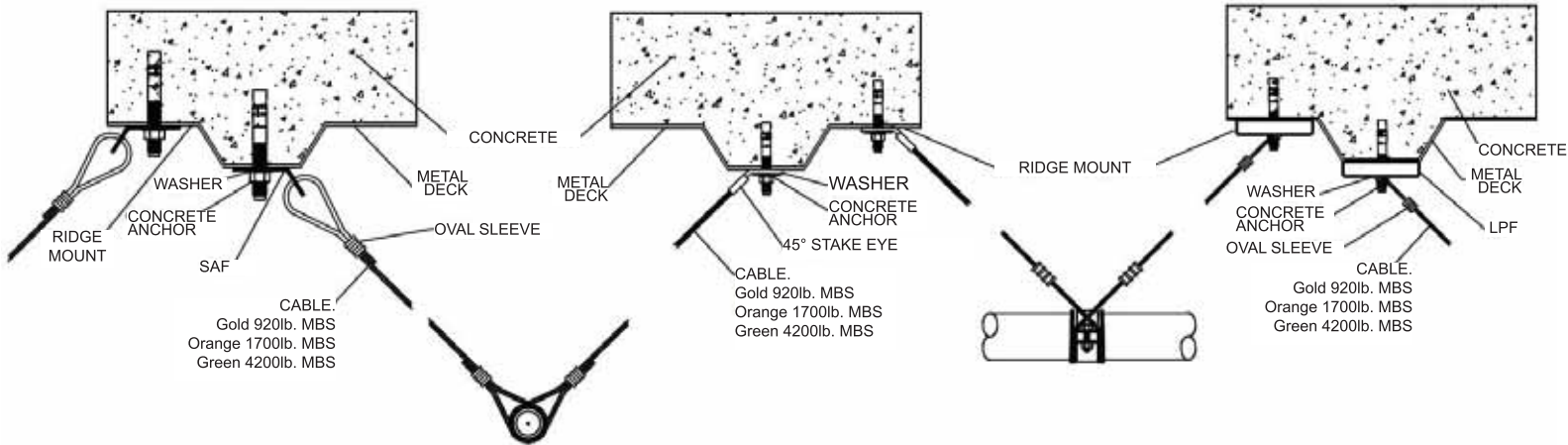

Maximum Load for Wedge Anchors in 3,000 psi (207 bar) Lightweight Cracked Concrete on Metal Deck

Fastener Diameter	Fastener Min. Nom. Embedment	Min. Slab Thickness	Max. Flute Center Offset	LPF			SAF (All)			Stake Eye		
				30°-44°	45°-59°	60°-90°	30°-44°	45°-59°	60°-90°	30°-44°	45°-59°	60°-90°
3/8"	2.375	6.25	1	123 lbs.	183 lbs.	233 lbs.	79 lbs.	133 lbs.	193 lbs.	79 lbs.	133 lbs.	193 lbs.
1/2"	3.750	6.25	1	147 lbs.	231 lbs.	310 lbs.	86 lbs.	160 lbs.	247 lbs.	86 lbs.	160 lbs.	247 lbs.
5/8"	3.875	6.25	1	188 lbs.	292 lbs.	387 lbs.	113 lbs.	204 lbs.	311 lbs.	N/A	N/A	N/A
3/4"	4.500	6.25	1	255 lbs.	380 lbs.	486 lbs.	165 lbs.	275 lbs.	402 lbs.	N/A	N/A	N/A



NFPA-13 2019

© Loos & Co., Inc. - Cableware® Division

Load: Perpendicular to Structural Member

Angles: A (30°), B (45°), and C (60°)

Material: Wedge Anchors in 3,000 PSI (207 bars) Normal Weight Cracked Concrete

Table: 18.5.12.2 (C)

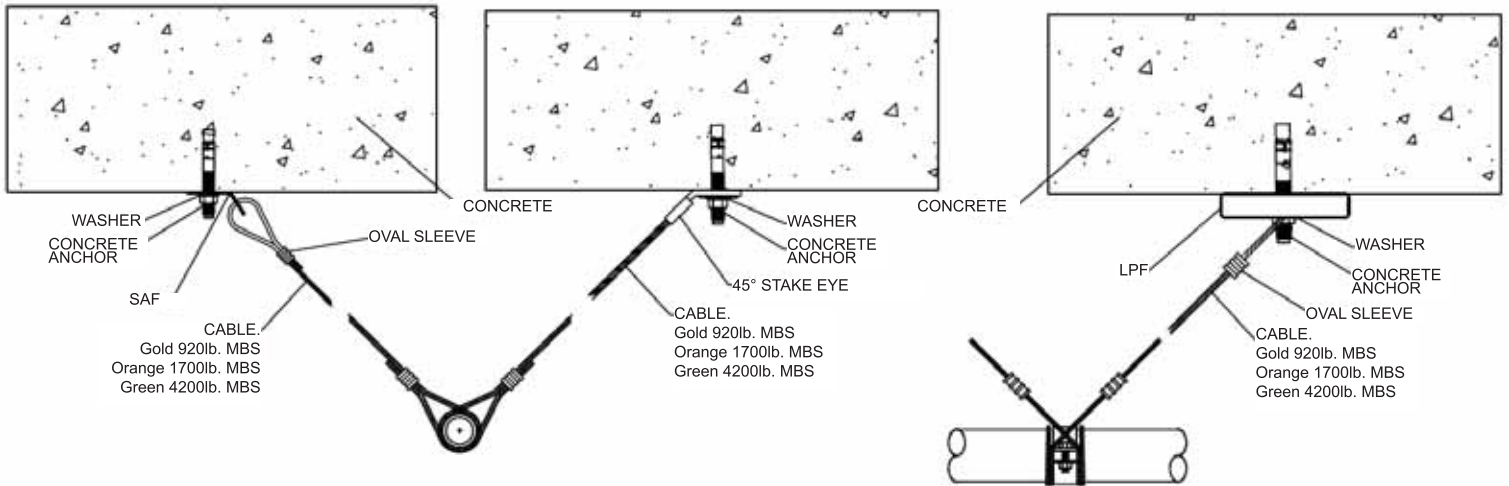

Maximum Load for Wedge Anchors in 3,000 psi (207 bar) Normal-Weight Cracked Concrete

Fastener Diameter	Fastener Min. Nom. Embedment	Min. Slab Thickness	Min. Edge Distance (in.)	LPF			SAF (All)			Stake Eye		
				30°-44°	45°-59°	60°-90°	30°-44°	45°-59°	60°-90°	30°-44°	45°-59°	60°-90°
3/8"	2.375	5	4	189 lbs.	274 lbs.	342 lbs.	125 lbs.	203 lbs.	288 lbs.	125 lbs.	203 lbs.	288 lbs.
1/2"	3.750	6	6	272 lbs.	423 lbs.	563 lbs.	162 lbs.	295 lbs.	451 lbs.	162 lbs.	295 lbs.	451 lbs.
5/8"	3.875	6	6	407 lbs.	623 lbs.	814 lbs.	252 lbs.	441 lbs.	662 lbs.	N/A	N/A	N/A
3/4"	4.500	7	8	613 lbs.	940 lbs.	1,232 lbs.	378 lbs.	665 lbs.	999 lbs.	N/A	N/A	N/A



NFPA-13 2019

INSTRUCTIONS

Load: Perpendicular to Structural Member

Angles: A (30°), B (45°), and C (60°)

Material: Wood Form Inserts in 3,000 PSI (207 bar) Normal Weight Cracked Concrete

Table: 18.5.12.2 (H)

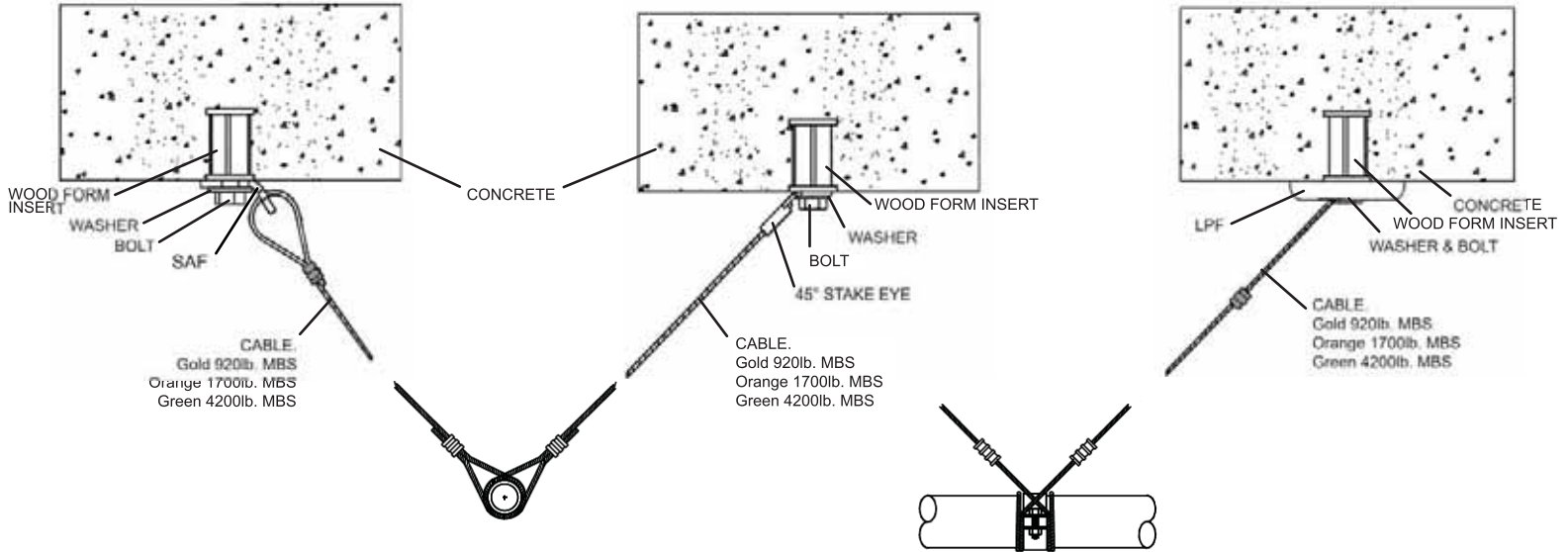

Maximum Load for Wood Form Inserts in 3,000 psi (207 bar) Normal-Weight Cracked

Fastener Diameter	Fastener Min. Nom. Embedment	Min. Slab Thickness	Min. Edge Distance (in.)	LPF			SAF (All)			Stake Eye		
				30°-44°	45°-59°	60°-90°	30°-44°	45°-59°	60°-90°	30°-44°	45°-59°	60°-90°
3/8"	1.100	4	6	248 lbs.	342 lbs.	411 lbs.	170 lbs.	264 lbs.	357 lbs.	170 lbs.	264 lbs.	357 lbs.
1/2"	1.690	4	6	297 lbs.	443 lbs.	565 lbs.	192 lbs.	321 lbs.	468 lbs.	192 lbs.	321 lbs.	468 lbs.
5/8"	1.750	4	8	297 lbs.	443 lbs.	565 lbs.	192 lbs.	321 lbs.	468 lbs.	N/A	N/A	N/A
3/4"	1.750	4	8	297 lbs.	443 lbs.	565 lbs.	192 lbs.	321 lbs.	468 lbs.	N/A	N/A	N/A



NFPA-13 2019

Load: Perpendicular to Structural Member

Angles: A (30°), B (45°), and C (60°)

Material: Wedge anchors in 3,000 PSI (207 bar) Light Weight Cracked Concrete

Table: 18.5.12.2 (B)

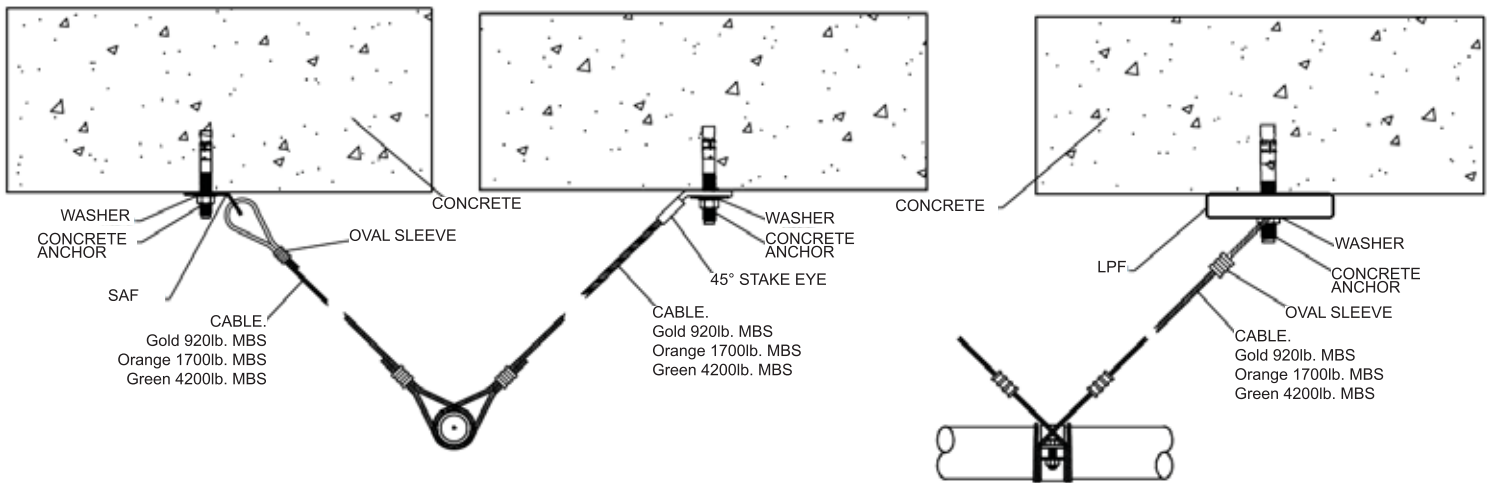

Maximum Load for Wedge Anchors in 3,000 psi (207 bar) Lightweight Cracked Concrete

Fastener Diameter	Fastener Min. Nom. Embedment	Min. Slab Thickness	Min. Edge Distance (in.)	LPF			SAF (All)			Stake Eye		
				30°-44°	45°-59°	60°-90°	30°-44°	45°-59°	60°-90°	30°-44°	45°-59°	60°-90°
3/8"	2.375	5	4	142 lbs.	216 lbs.	280 lbs.	89 lbs.	154 lbs.	229 lbs.	89 lbs.	154 lbs.	229 lbs.
1/2"	3.750	6	6	200 lbs.	314 lbs.	419 lbs.	119 lbs.	218 lbs.	335 lbs.	119 lbs.	218 lbs.	335 lbs.
5/8"	3.875	6	6	259 lbs.	394 lbs.	512 lbs.	163 lbs.	281 lbs.	418 lbs.	N/A	N/A	N/A
3/4"	4.500	7	8	356 lbs.	552 lbs.	731 lbs.	214 lbs.	386 lbs.	588 lbs.	N/A	N/A	N/A



NFPA-13 2019

INSTRUCTIONS

Load: Perpendicular to Structural Member

Angles: A (30°), B (45°), and C (60°)

Material: Wedge Anchors in 4,000 PSI (276 bar) Normal Weight Cracked Concrete

Table: 18.5.12.2 (D)

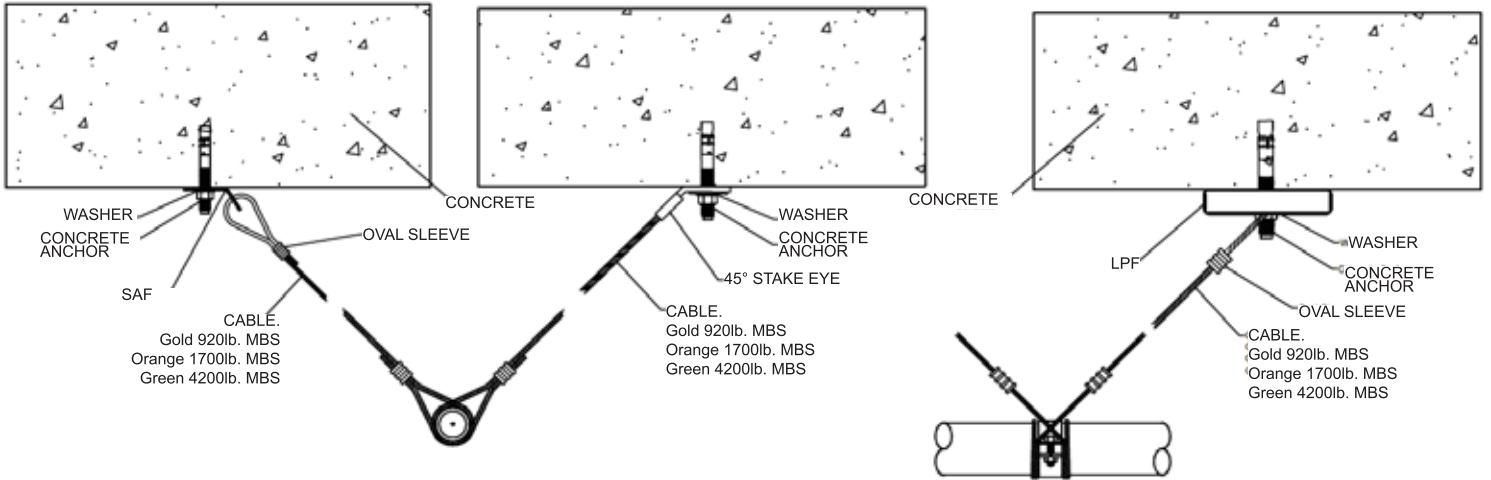

Maximum Load for Wedge Anchors in 4,000 psi (267 bar) Normal-Weight Cracked Concrete

Fastener Diameter	Fastener Min. Nom. Embedment	Min. Slab Thickness	Min. Edge Distance (in.)	LPF			SAF (All)			Stake Eye		
				30°-44°	45°-59°	60°-90°	30°-44°	45°-59°	60°-90°	30°-44°	45°-59°	60°-90°
3/8"	2.375	5	4	206 lbs.	293 lbs.	360 lbs.	138 lbs.	221 lbs.	307 lbs.	138 lbs.	221 lbs.	307 lbs.
1/2"	3.750	6	6	304 lbs.	466 lbs.	610 lbs.	188 lbs.	330 lbs.	495 lbs.	188 lbs.	330 lbs.	495 lbs.
5/8"	3.875	6	6	469 lbs.	716 lbs.	935 lbs.	291 lbs.	508 lbs.	761 lbs.	N/A	N/A	N/A
3/4"	4.500	7	8	657 lbs.	997 lbs.	1,293 lbs.	414 lbs.	711 lbs.	1,057 lbs.	N/A	N/A	N/A



NFPA-13 2019

Load: Perpendicular to Structural Member

Angles: A (30°), B (45°), and C (60°)

Material: Wedge Anchors in 6,000 PSI (414 bar) Normal Weight Cracked Concrete

Table: 18.5.12.2 (E)

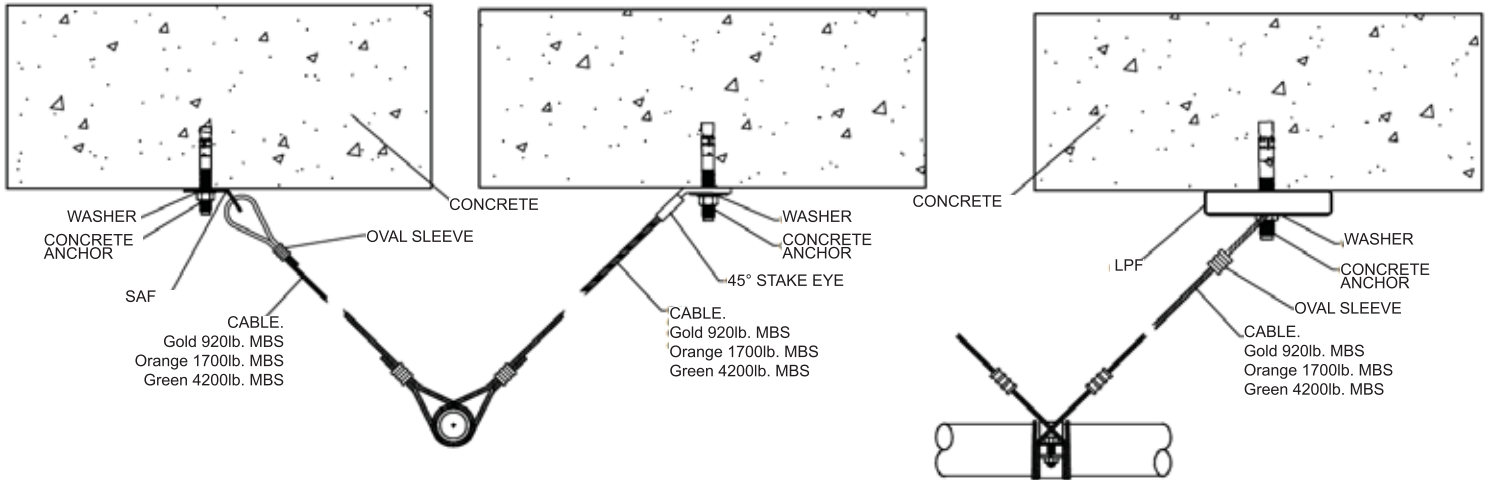

Maximum Load for Wedge Anchors in 6,000 psi (414 bar) Normal-Weight Cracked Concrete

Fastener Diameter	Fastener Min. Nom. Embedment	Min. Slab Thickness	Min. Edge Distance (in.)	LPF			SAF (All)			Stake Eye		
				30°-44°	45°-59°	60°-90°	30°-44°	45°-59°	60°-90°	30°-44°	45°-59°	60°-90°
3/8"	2.375	5	4	225 lbs.	313 lbs.	379 lbs.	153 lbs.	240 lbs.	327 lbs.	153 lbs.	240 lbs.	327 lbs.
1/2"	3.750	6	6	354 lbs.	529 lbs.	676 lbs.	228 lbs.	382 lbs.	559 lbs.	228 lbs.	382 lbs.	559 lbs.
5/8"	3.875	6	6	546 lbs.	812 lbs.	1,036 lbs.	353 lbs.	589 lbs.	859 lbs.	N/A	N/A	N/A
3/4"	4.500	7	8	763 lbs.	1,127 lbs.	1,429 lbs.	496 lbs.	822 lbs.	1,190 lbs.	N/A	N/A	N/A



NFPA-13 2019

INSTRUCTIONS

Load: Perpendicular to Structural Member

Angles: A (30°), B (45°), and C (60°)

Material: Connections to Steel Using Unfinished Steel Bolts

Table: 18.5.12.2 (K)

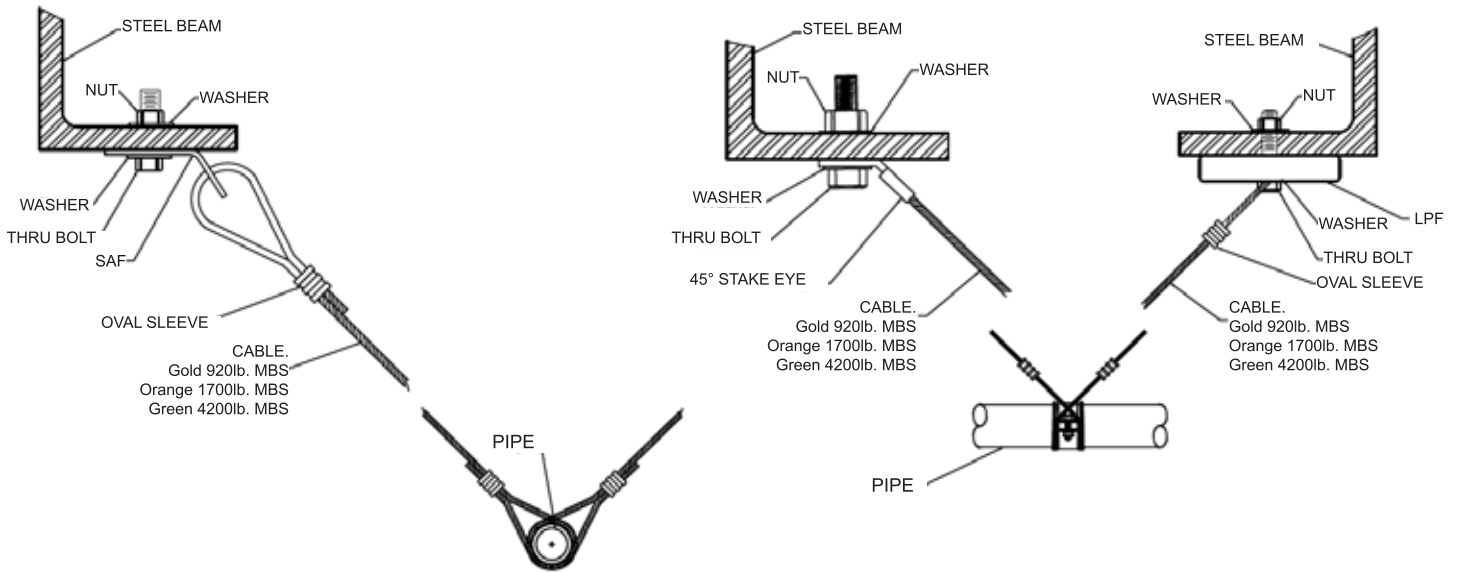

Diameter	30° - 44°	45° - 59°	60° - 90°
1/4"	400 lbs.	500 lbs.	600 lbs.
3/8"	900 lbs.	1,200 lbs.	1,400 lbs.
1/2"	1,600 lbs.	2,050 lbs.	2,550 lbs.
5/8"	2,500 lbs.	3,300 lbs.	3,950 lbs.



NFPA-13 2019

© Loos & Co., Inc. - Cableware® Division

Load: Perpendicular to Structural Member

Angles: D (30°), E (45°), and F (60°)

Material: Through-Bolts in Sawn Lumber or Glue-Laminated Timber

Table: 18.5.12.2 (L)

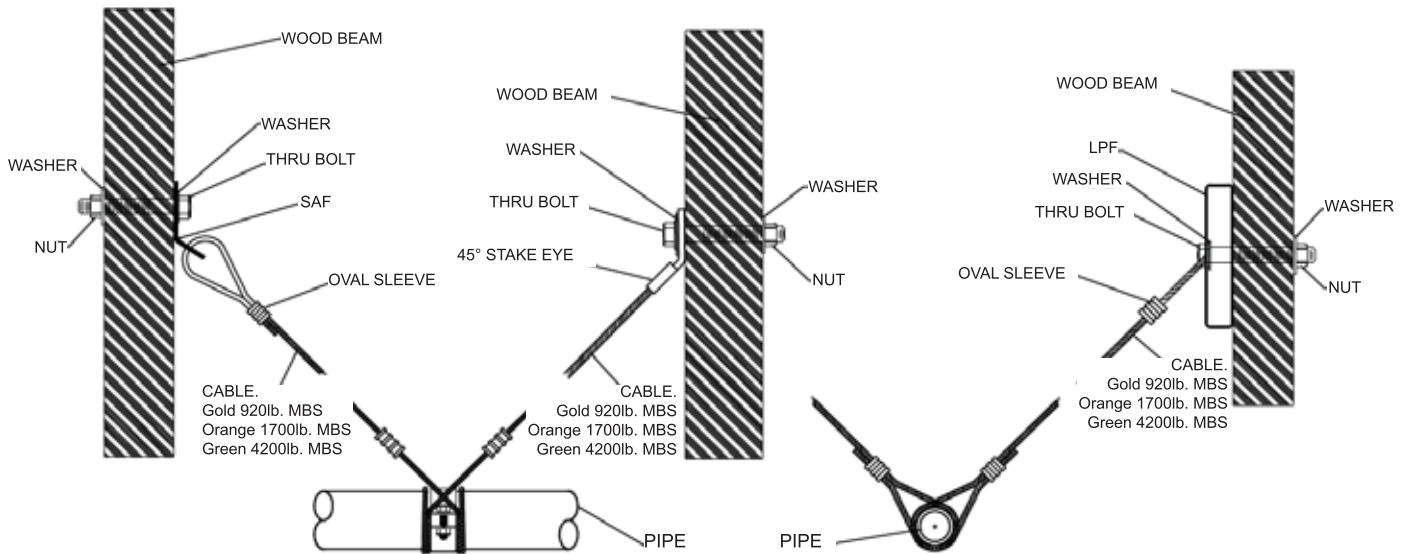

Bolt Length	1/2" Bolt Diameter			5/8" Bolt Diameter			3/4" Bolt Diameter		
	30° - 44°	45° - 59°	60° - 90°	30° - 44°	45° - 59°	60° - 90°	30° - 44°	45° - 59°	60° - 90°
1-1/2"	135 lbs.	230 lbs.	395 lbs.	155 lbs.	270 lbs.	460 lbs.	180 lbs.	310 lbs.	530 lbs.
2-1/2"	160 lbs.	280 lbs.	480 lbs.	185 lbs.	320 lbs.	550 lbs.	205 lbs.	360 lbs.	615 lbs.
3-1/2"	200 lbs.	350 lbs.	600 lbs.	230 lbs.	400 lbs.	685 lbs.	255 lbs.	440 lbs.	755 lbs.
5-1/2"	N/A	N/A	N/A	325 lbs.	560 lbs.	960 lbs.	360 lbs.	620 lbs.	1,065 lbs.

Above listed values based on wood with a specific gravity of 0.35. Values for other woods can be obtained by multiplying above values by factors listed in Figure 1.

Figure 1

Specific Gravity of Wood	Multiplier
0.36 - 0.49	1.17
0.50 - 0.65	1.25
0.66 - 0.73	1.50



NFPA-13 2019

INSTRUCTIONS

Load: Perpendicular to Structural Member

Angles: D (30°), E (45°), and F (60°)

Material: Lag Screw and Lag Bolts in wood

Table: 18.5.12.2 (M)

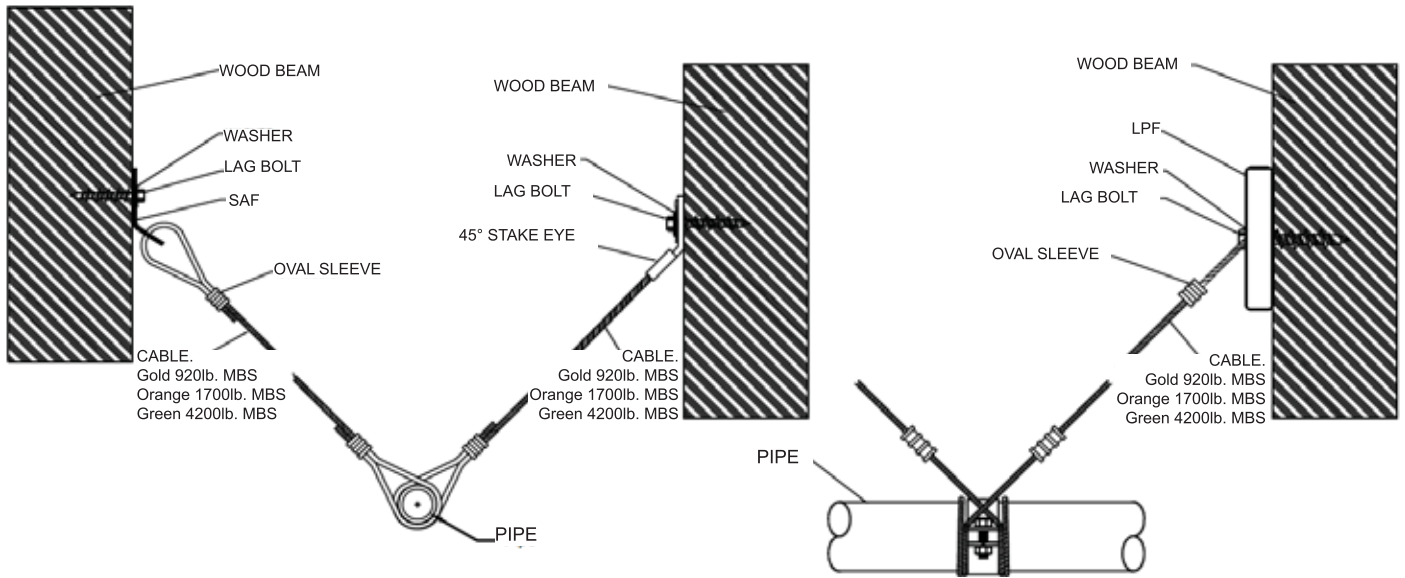

Lag Length	3/8" Lag Diameter			1/2" Lag Diameter			5/8" Lag Diameter		
	30° - 44°	45° - 59°	60° - 90°	30° - 44°	45° - 59°	60° - 90°	30° - 44°	45° - 59°	60° - 90°
3-1/2"	170 lbs.	220 lbs.	310 lbs.						
4-1/2"	175 lbs.	235 lbs.	350 lbs.	315 lbs.	400 lbs.	550 lbs.			
5-1/2"	175 lbs.	245 lbs.	380 lbs.	320 lbs.	420 lbs.	610 lbs.	425 lbs.	550 lbs.	775 lbs.
6-1/2"	175 lbs.	250 lbs.	400 lbs.	325 lbs.	435 lbs.	650 lbs.	430 lbs.	570 lbs.	840 lbs.

Above listed values based on wood with a specific gravity of 0.35. Values for other woods can be obtained by multiplying above values by factors listed in Figure 1.

Figure 1

Specific Gravity of Wood	Multiplier
0.36 - 0.49	1.17
0.50 - 0.65	1.25
0.66 - 0.73	1.50



NFPA-13 2019

Load: Perpendicular to Structural Member

Angles: D (30°), E (45°), and F (60°)

Material: Wedge Anchors in 3,000 PSI (207 bars) Normal Weight Cracked Concrete

Table: 18.5.12.2 (C)

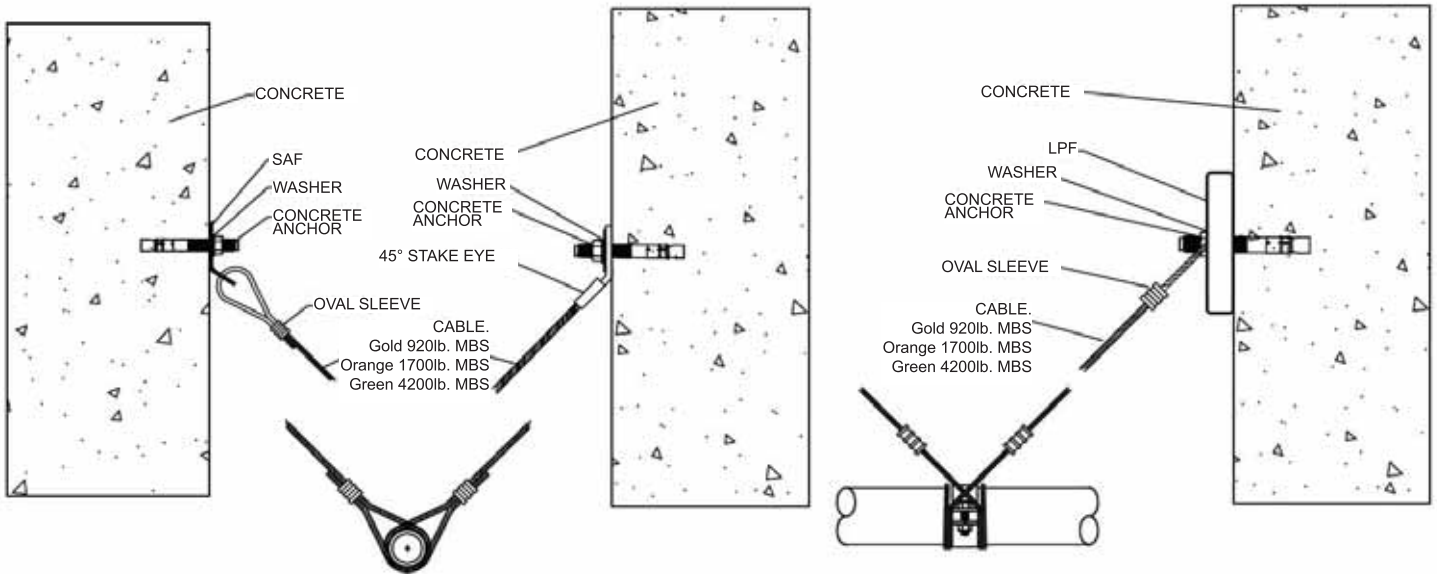

Maximum Load for Wedge Anchors in 3,000 psi (207 bar) Normal-Weight Cracked Concrete

Fastener Diameter	Fastener Min. Nom. Embedment	Min. Slab Thickness	Min. Edge Distance (in.)	LPF			SAF (All)			Stake Eye		
				30°-44°	45°-59°	60°-90°	30°-44°	45°-59°	60°-90°	30°-44°	45°-59°	60°-90°
3/8"	2.375	5	4	197 lbs.	274 lbs.	340 lbs.	167 lbs.	203 lbs.	219 lbs.	167 lbs.	203 lbs.	219 lbs.
1/2"	3.750	6	6	326 lbs.	423 lbs.	490 lbs.	263 lbs.	295 lbs.	285 lbs.	263 lbs.	295 lbs.	285 lbs.
5/8"	3.875	6	6	472 lbs.	623 lbs.	733 lbs.	386 lbs.	441 lbs.	442 lbs.	N/A	N/A	N/A
3/4"	4.500	7	8	715 lbs.	940 lbs.	1,104 lbs.	583 lbs.	665 lbs.	662 lbs.	N/A	N/A	N/A



NFPA-13 2019

INSTRUCTIONS

Load: Perpendicular to Structural Member

Angles: D (30°), E (45°), and F (60°)

Material: Wood Form Insert in 3,000 PSI (207 bar) Normal Weight Cracked Concrete

Table: 18.5.12.2 (H)

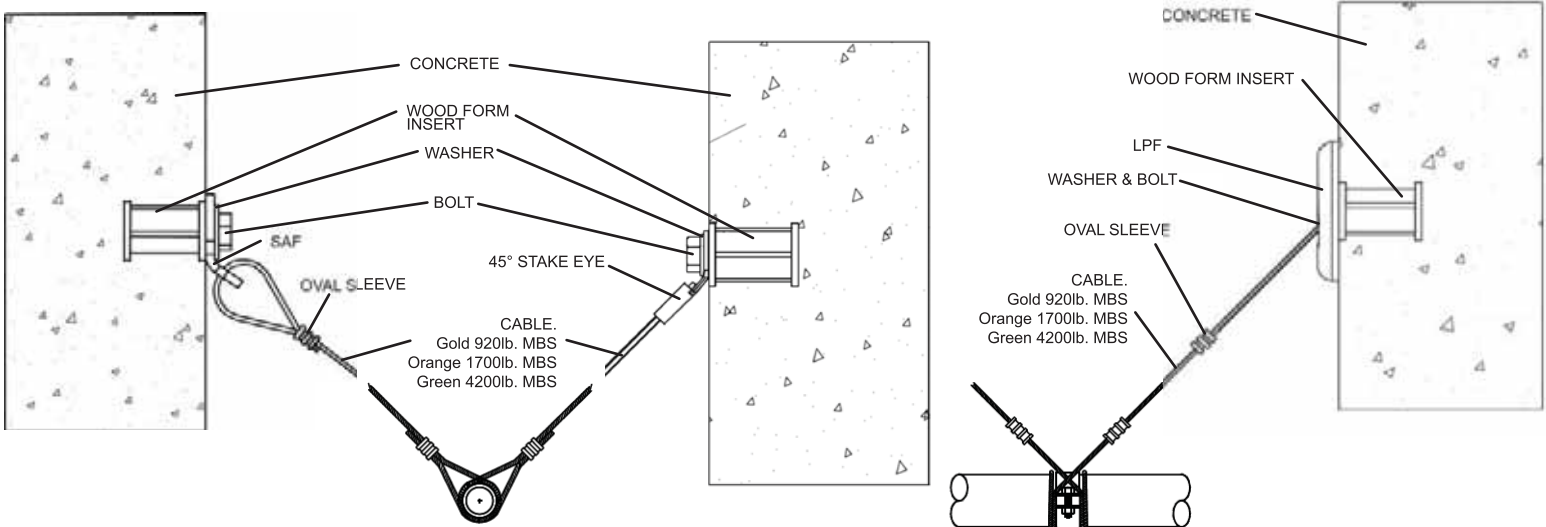

Maximum Load for Wood Form Insert in 3,000 psi (207 bar) Normal-Weight Cracked Concrete

Fastener Diameter	Fastener Min. Nom. Embedment	Min. Slab Thickness	Min. Edge Distance (in.)	LPF			SAF (All)			Stake Eye		
				30°-44°	45°-59°	60°-90°	30°-44°	45°-59°	60°-90°	30°-44°	45°-59°	60°-90°
3/8"	1.100	4	6	237 lbs.	342 lbs.	444 lbs.	207 lbs.	264 lbs.	298 lbs.	207 lbs.	264 lbs.	298 lbs.
1/2"	1.690	4	6	327 lbs.	443 lbs.	535 lbs.	272 lbs.	321 lbs.	336 lbs.	272 lbs.	321 lbs.	336 lbs.
5/8"	1.750	4	8	327 lbs.	443 lbs.	535 lbs.	272 lbs.	321 lbs.	336 lbs.	N/A	N/A	N/A
3/4"	1.750	4	8	327 lbs.	443 lbs.	535 lbs.	272 lbs.	321 lbs.	336 lbs.	N/A	N/A	N/A



NFPA-13 2019

Load: Perpendicular to Structural Member

Angles: D (30°), E (45°), and F (60°)

Material: Wedge Anchors in 3,000 PSI (207 bar) Light Weight Cracked Concrete

Table: 18.5.12.2 (B)

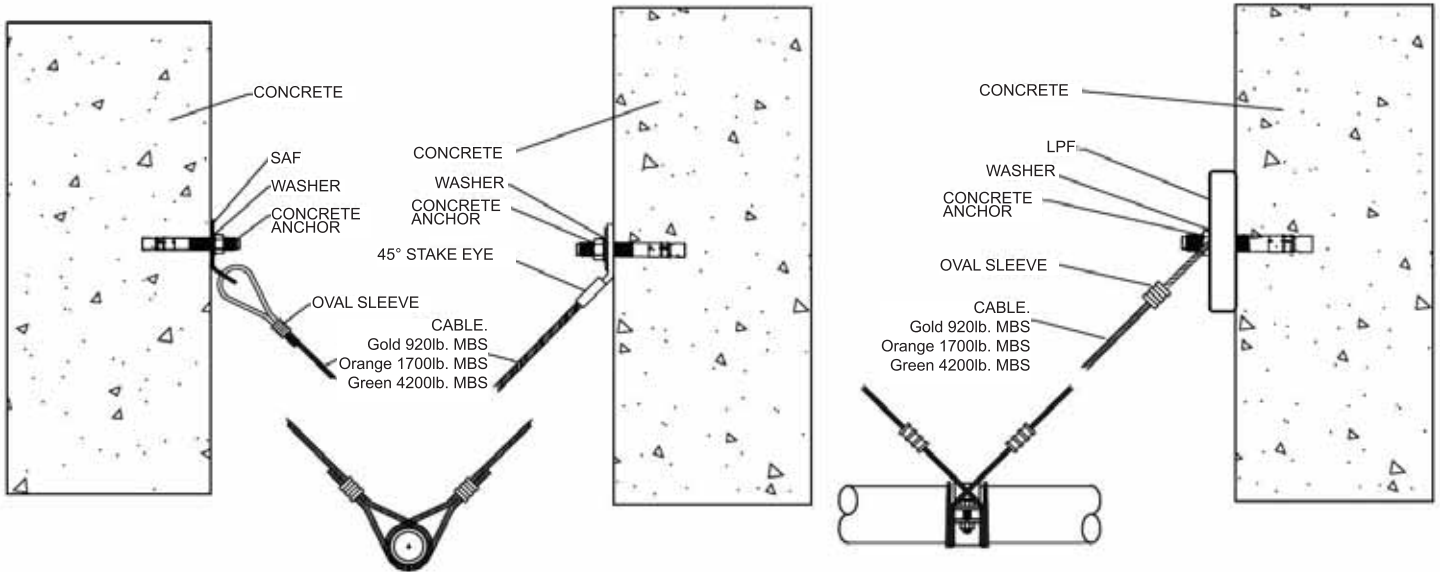

Maximum Load for Wedge Anchors in 3,000 psi (207 bar) Lightweight Cracked Concrete

Fastener Diameter	Fastener Min. Nom. Embedment	Min. Slab Thickness	Min. Edge Distance (in.)	LPF			SAF (All)			Stake Eye		
				30°-44°	45°-59°	60°-90°	30°-44°	45°-59°	60°-90°	30°-44°	45°-59°	60°-90°
3/8"	2.375	5	4	162 lbs.	216 lbs.	256 lbs.	133 lbs.	154 lbs.	157 lbs.	133 lbs.	154 lbs.	157 lbs.
1/2"	3.750	6	6	243 lbs.	314 lbs.	362 lbs.	195 lbs.	218 lbs.	209 lbs.	195 lbs.	218 lbs.	209 lbs.
5/8"	3.875	6	6	297 lbs.	394 lbs.	467 lbs.	244 lbs.	281 lbs.	286 lbs.	N/A	N/A	N/A
3/4"	4.500	7	8	424 lbs.	552 lbs.	641 lbs.	343 lbs.	386 lbs.	376 lbs.	N/A	N/A	N/A



NFPA-13 2019

INSTRUCTIONS

Load: Perpendicular to Structural Member

Angles: D (30°), E (45°), and F (60°)

Material: Wedge Anchors in 4,000 PSI (276 bar) Normal Weight Cracked Concrete

Table: 18.5.12.2 (D)

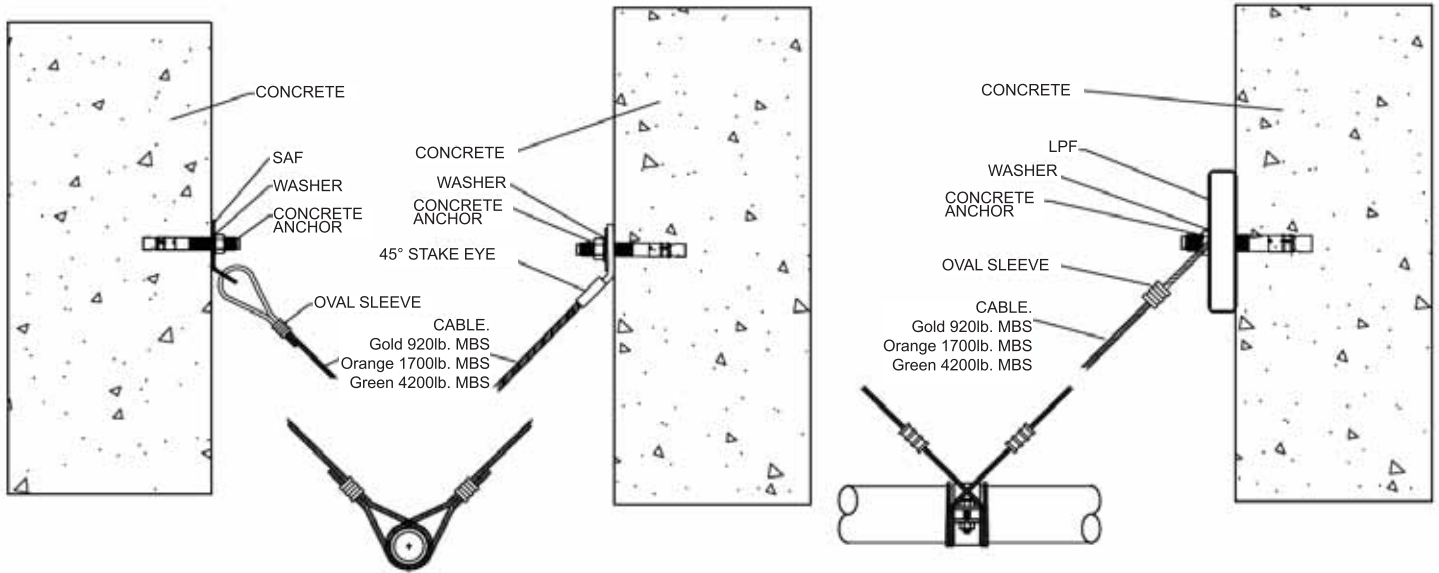

Maximum Load for Wedge Anchors in 4,000 psi (276 bar) Normal-Weight Cracked Concrete

Fastener Diameter	Fastener Min. Nom. Embedment	Min. Slab Thickness	Min. Edge Distance (in.)	LPF			SAF (All)			Stake Eye		
				30°-44°	45°-59°	60°-90°	30°-44°	45°-59°	60°-90°	30°-44°	45°-59°	60°-90°
3/8"	2.375	5	4	208 lbs.	293 lbs.	370 lbs.	178 lbs.	221 lbs.	242 lbs.	178 lbs.	221 lbs.	242 lbs.
1/2"	3.750	6	6	353 lbs.	466 lbs.	548 lbs.	289 lbs.	330 lbs.	330 lbs.	289 lbs.	330 lbs.	330 lbs.
5/8"	3.875	6	6	542 lbs.	716 lbs.	844 lbs.	444 lbs.	508 lbs.	511 lbs.	N/A	N/A	N/A
3/4"	4.500	7	8	750 lbs.	997 lbs.	1,182 lbs.	617 lbs.	711 lbs.	725 lbs.	N/A	N/A	N/A



NFPA-13 2019

Load: Perpendicular to Structural Member

Angles: D (30°), E (45°), and F (60°)

Material: Wedge Anchors in 6,000 PSI (414 bar) Normal Weight Cracked Concrete

Table: 18.5.12.2 (E)

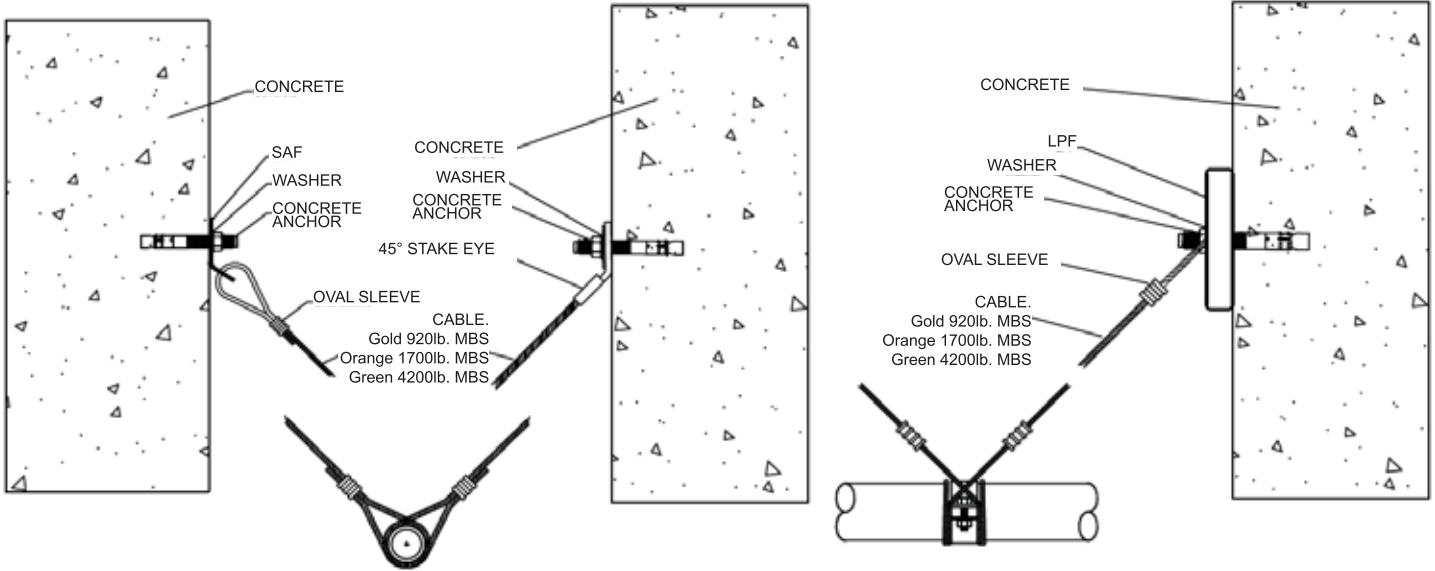

Maximum Load for Wedge Anchors in 6,000 psi (414 bar) Normal-Weight Cracked Concrete

Fastener Diameter	Fastener Min. Nom. Embedment	Min. Slab Thickness	Min. Edge Distance (in.)	LPF			SAF (All)			Stake Eye		
				30°-44°	45°-59°	60°-90°	30°-44°	45°-59°	60°-90°	30°-44°	45°-59°	60°-90°
3/8"	2.375	5	4	219 lbs.	313 lbs.	402 lbs.	190 lbs.	240 lbs.	267 lbs.	190 lbs.	240 lbs.	267 lbs.
1/2"	3.750	6	6	392 lbs.	529 lbs.	637 lbs.	326 lbs.	382 lbs.	400 lbs.	326 lbs.	382 lbs.	400 lbs.
5/8"	3.875	6	6	601 lbs.	812 lbs.	981 lbs.	500 lbs.	589 lbs.	617 lbs.	N/A	N/A	N/A
3/4"	4.500	7	8	829 lbs.	1,127 lbs.	1,370 lbs.	693 lbs.	822 lbs.	868 lbs.	N/A	N/A	N/A



NFPA-13 2019

INSTRUCTIONS

Load: Perpendicular to Structural Member

Angles: D (30°), E (45°), and F (60°)

Material: Connections to Steel Using Unfinished Steel Bolts

Table: 18.5.12.2 (K)

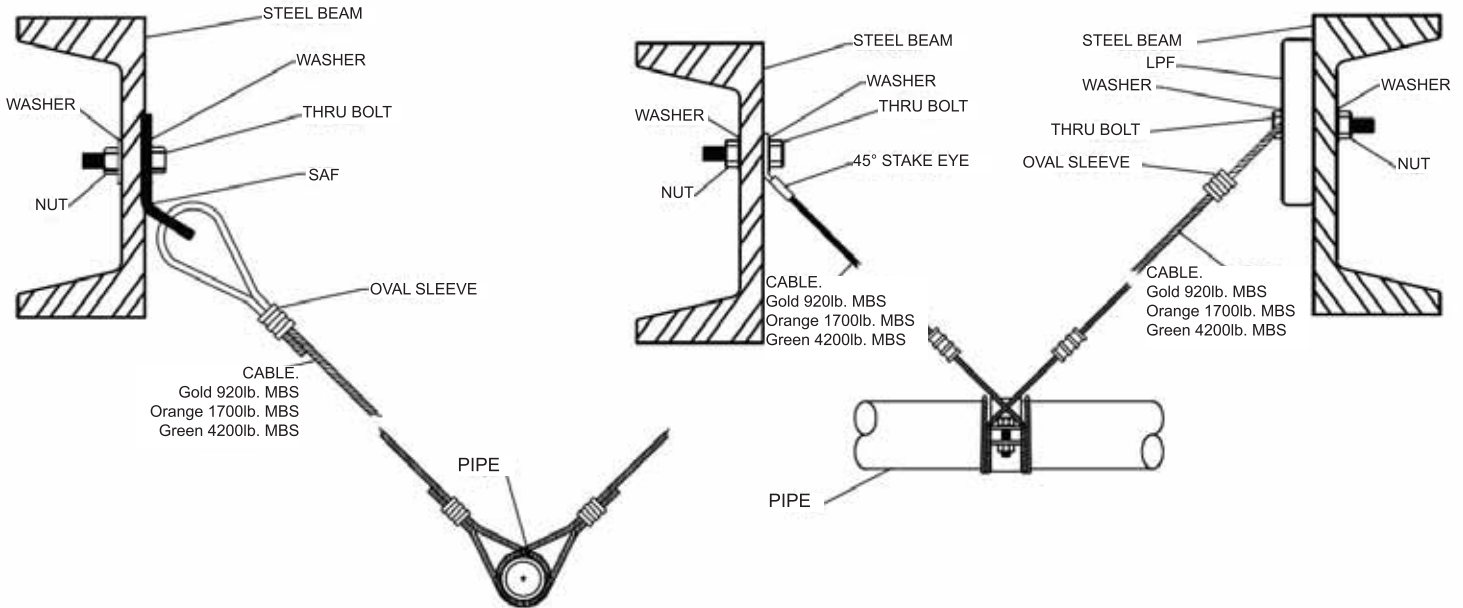

Diameter	30° - 44°	45° - 59°	60° - 90°
1/4"	300 lbs.	500 lbs.	650 lbs.
3/8"	800 lbs.	1,200 lbs.	1,550 lbs.
1/2"	1,450 lbs.	2,050 lbs.	2,850 lbs.
5/8"	2,250 lbs.	3,300 lbs.	4,400 lbs.



NFPA-13 2019

Load: Parallel to Structural Member

Angles: G (30°), H (45°), and I (60°)

Material: Through-Bolts in Sawn Lumber or Glue-Laminated Timbers

Table: 18.5.12.2 (L)

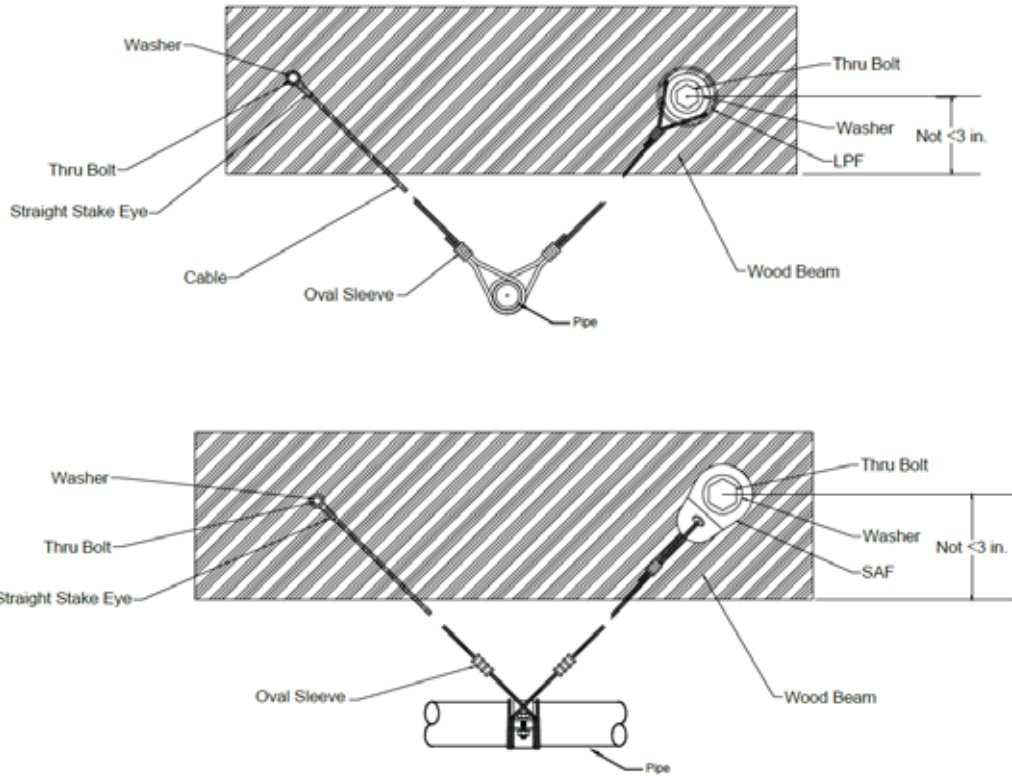

Bolt Length	1/2" Bolt Diameter			5/8" Bolt Diameter			3/4" Bolt Diameter		
	30° - 44°	45° - 59°	60° - 90°	30° - 44°	45° - 59°	60° - 90°	30° - 44°	45° - 59°	60° - 90°
1-1/2"	130 lbs.	215 lbs.	310 lbs.	155 lbs.	255 lbs.	380 lbs.	170 lbs.	300 lbs.	450 lbs.
2-1/2"	165 lbs.	275 lbs.	410 lbs.	190 lbs.	320 lbs.	495 lbs.	215 lbs.	365 lbs.	575 lbs.
3-1/2"	200 lbs.	330 lbs.	485 lbs.	235 lbs.	405 lbs.	635 lbs.	260 lbs.	455 lbs.	730 lbs.
5-1/2"	N/A	N/A	N/A	315 lbs.	515 lbs.	735 lbs.	360 lbs.	610 lbs.	925 lbs.

Above listed values based on wood with a specific gravity of 0.35. Values for other woods can be obtained by multiplying above values by factors listed in Figure 1.

Figure 1

Specific Gravity of Wood	Multiplier
0.36 - 0.49	1.17
0.50 - 0.65	1.25
0.66 - 0.73	1.50



NFPA-13 2019

INSTRUCTIONS

Load: Parallel to Structural Member

Angles: G (30°), H (45°), and I (60°)

Material: Lag Screw and Lag Bolts in Wood

Table: 18.5.12.2 (M)

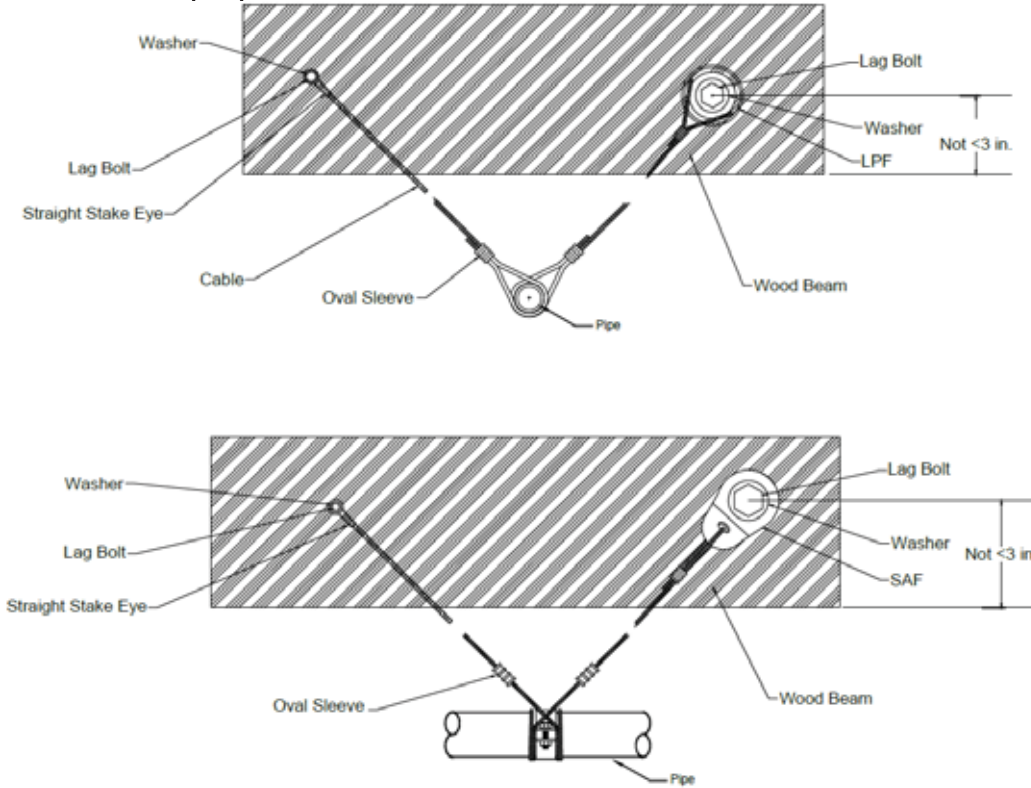

Lag Length	3/8" Lag Diameter			1/2" Lag Diameter			5/8" Lag Diameter		
	30° - 44°	45° - 59°	60° - 90°	30° - 44°	45° - 59°	60° - 90°	30° - 44°	45° - 59°	60° - 90°
3-1/2"	80 lbs.	120 lbs.	170 lbs.						
4-1/2"	80 lbs.	120 lbs.	170 lbs.	145 lbs.	230 lbs.	325 lbs.			
5-1/2"	80 lbs.	120 lbs.	170 lbs.	145 lbs.	230 lbs.	325 lbs.	195 lbs.	320 lbs.	460 lbs.
6-1/2"	80 lbs.	120 lbs.	170 lbs.	145 lbs.	230 lbs.	325 lbs.	195 lbs.	320 lbs.	460 lbs.

Above listed values based on wood with a specific gravity of 0.35. Values for other woods can be obtained by multiplying above values by factors listed in Figure 1.

Figure 1

Specific Gravity of Wood	Multiplier
0.36 - 0.49	1.17
0.50 - 0.65	1.25
0.66 - 0.73	1.50



NFPA-13 2019

Load: Parallel to Structural Member

Angles: G (30°), H (45°), and I (60°)

Material: Wedge Anchors in 3,000 PSI (207 bar) Normal Weight Cracked Concrete

Table: 18.5.12.2 (C)

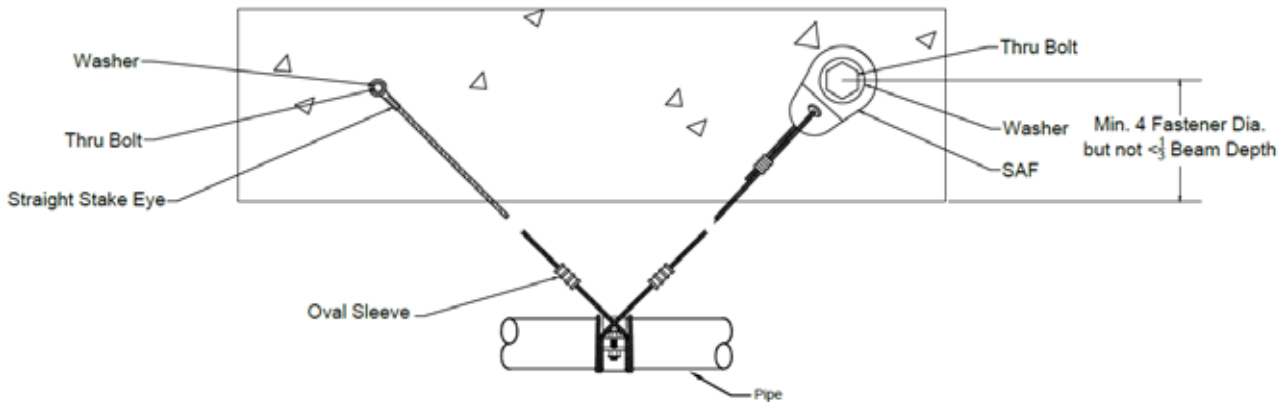
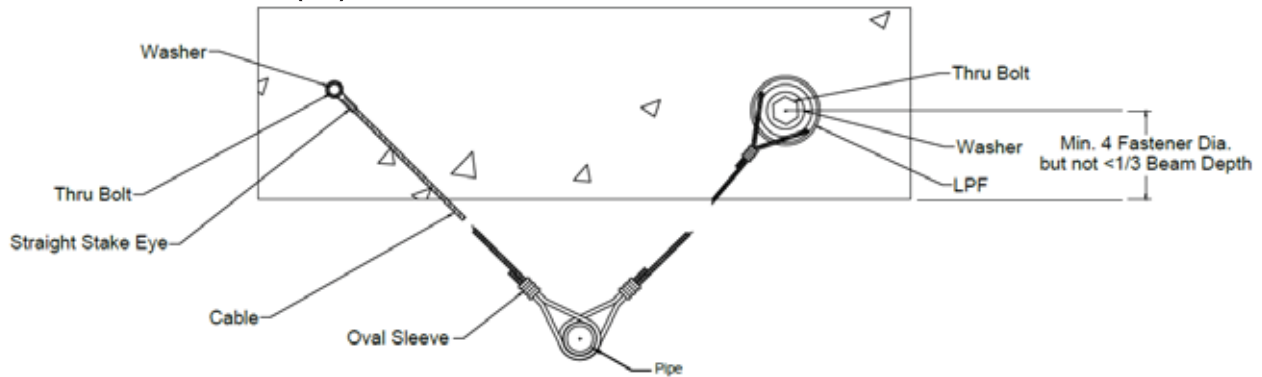

Maximum Load for Wedge Anchors in 3,000 psi (207 bar) Normal-Weight Cracked Concrete

Fastener Diameter	Fastener Min. Nom. Embedment	Min. Slab Thickness	Min. Edge Distance (in.)	LPF			SAF (All)			Stake Eye		
				30°-44°	45°-59°	60°-90°	30°-44°	45°-59°	60°-90°	30°-44°	45°-59°	60°-90°
3/8"	2.375	5	4	170 lbs.	251 lbs.	297 lbs.	147 lbs.	212 lbs.	256 lbs.	147 lbs.	212 lbs.	256 lbs.
1/2"	3.750	6	6	281 lbs.	419 lbs.	490 lbs.	233 lbs.	337 lbs.	403 lbs.	233 lbs.	337 lbs.	403 lbs.
5/8"	3.875	6	6	406 lbs.	605 lbs.	709 lbs.	341 lbs.	492 lbs.	590 lbs.	N/A	N/A	N/A
3/4"	4.500	7	8	615 lbs.	916 lbs.	1,073 lbs.	515 lbs.	744 lbs.	892 lbs.	N/A	N/A	N/A



NFPA-13 2019

INSTRUCTIONS

Load: Parallel to Structural Member

Angles: G (30°), H (45°), and I (60°)

Material: Wood Form Inserts in 3,000 PSI (207 bar) Normal Weight Cracked Concrete

Table: 18.5.12.2 (H)

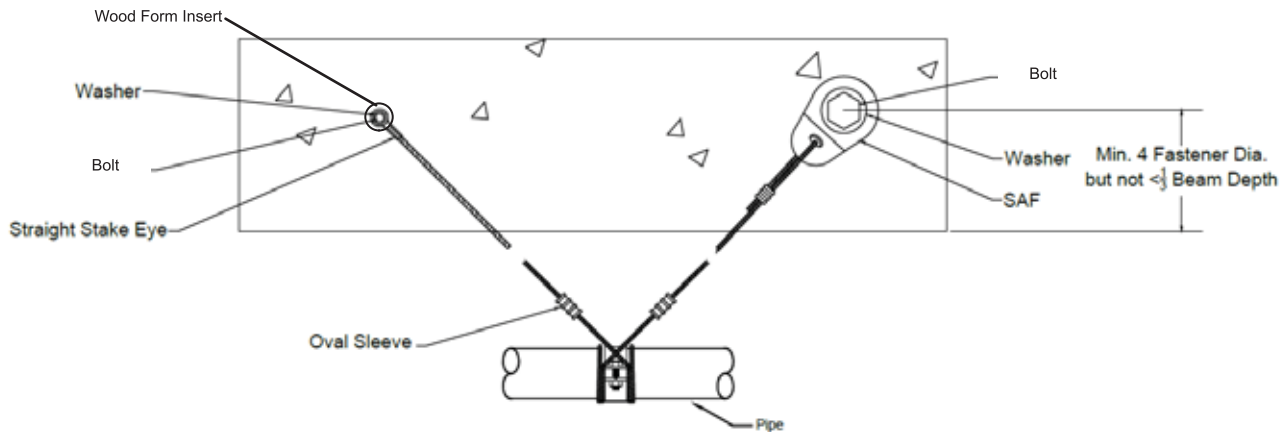
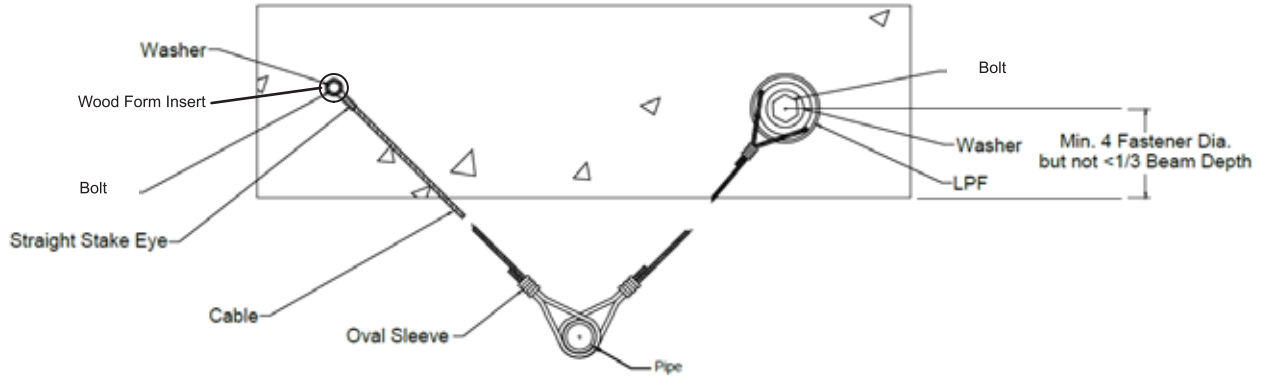

Maximum Load for Wood Form Inserts in 3,000 psi (207 bar) Normal-Weight Cracked Concrete

Fastener Diameter	Fastener Min. Nom. Embedment	Min. Slab Thickness	Min. Edge Distance (in.)	LPF			SAF (All)			Stake Eye		
				30°-44°	45°-59°	60°-90°	30°-44°	45°-59°	60°-90°	30°-44°	45°-59°	60°-90°
3/8"	1.100	4	6	205 lbs.	300 lbs.	357 lbs.	182 lbs.	261 lbs.	315 lbs.	182 lbs.	261 lbs.	315 lbs.
1/2"	1.690	4	6	282 lbs.	418 lbs.	492 lbs.	240 lbs.	347 lbs.	416 lbs.	240 lbs.	347 lbs.	416 lbs.
5/8"	1.750	4	8	282 lbs.	418 lbs.	492 lbs.	240 lbs.	347 lbs.	416 lbs.	N/A	N/A	N/A
3/4"	1.750	4	8	282 lbs.	418 lbs.	492 lbs.	240 lbs.	347 lbs.	416 lbs.	N/A	N/A	N/A



NFPA-13 2019

Load: Parallel to Structural Member

Angles: G (30°), H (45°), and I (60°)

Material: Wedge Anchors in 3,000 PSI (207 bar) Light Weight Cracked Concrete

Table: 18.5.12.2 (B)

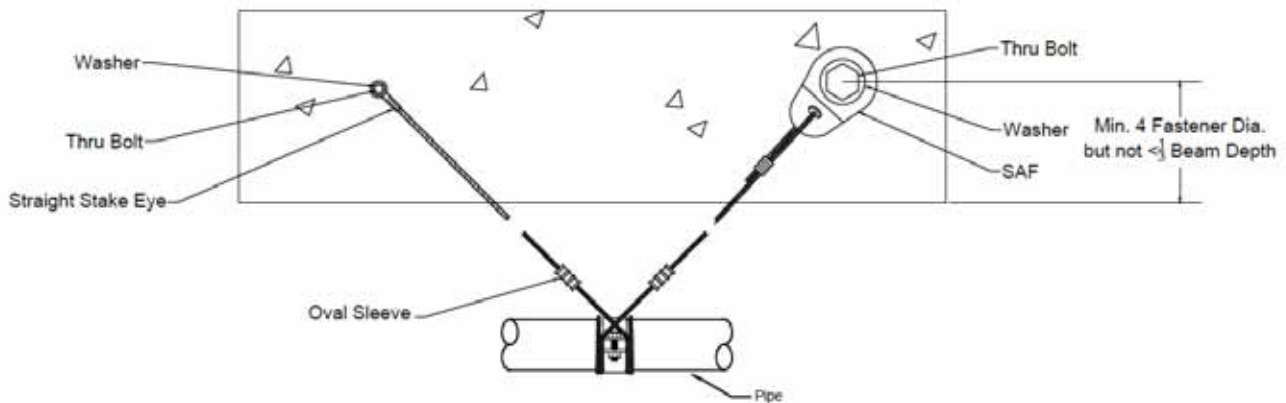
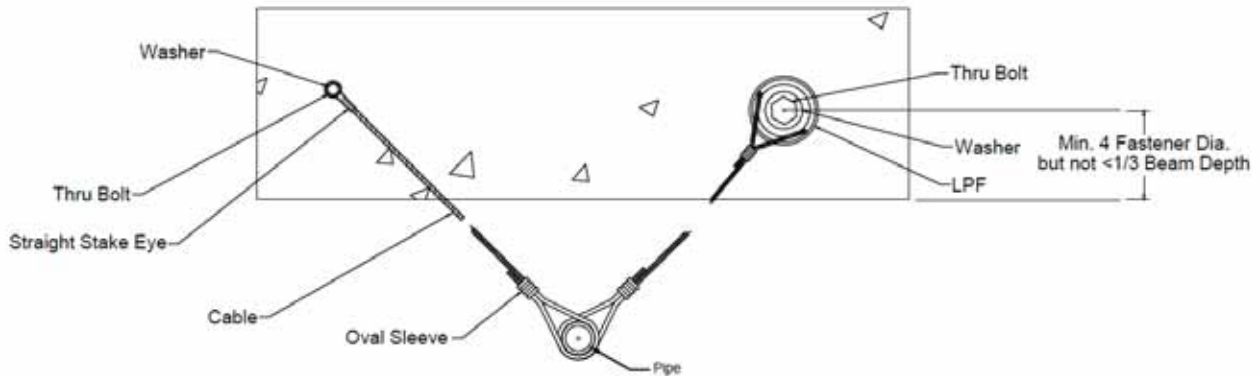

Maximum Load for Wedge Anchors in 3,000 psi (207 bar) Lightweight Cracked Concrete

Fastener Diameter	Fastener Min. Nom. Embedment	Min. Slab Thickness	Min. Edge Distance (in.)	LPF			SAF (All)			Stake Eye		
				30°-44°	45°-59°	60°-90°	30°-44°	45°-59°	60°-90°	30°-44°	45°-59°	60°-90°
3/8"	2.375	5	4	139 lbs.	208 lbs.	244 lbs.	117 lbs.	170 lbs.	204 lbs.	117 lbs.	170 lbs.	204 lbs.
1/2"	3.750	6	6	209 lbs.	312 lbs.	365 lbs.	172 lbs.	250 lbs.	299 lbs.	172 lbs.	250 lbs.	299 lbs.
5/8"	3.875	6	6	255 lbs.	380 lbs.	446 lbs.	215 lbs.	311 lbs.	373 lbs.	N/A	N/A	N/A
3/4"	4.500	7	8	365 lbs.	544 lbs.	636 lbs.	303 lbs.	438 lbs.	525 lbs.	N/A	N/A	N/A



NFPA-13 2019

INSTRUCTIONS

Load: Parallel to Structural Member

Angles: G (30°), H (45°), and I (60°)

Material: Wedge Anchors in 4,000 PSI (276 bar) Normal Weight Cracked Concrete

Table: 18.5.12.2 (D)

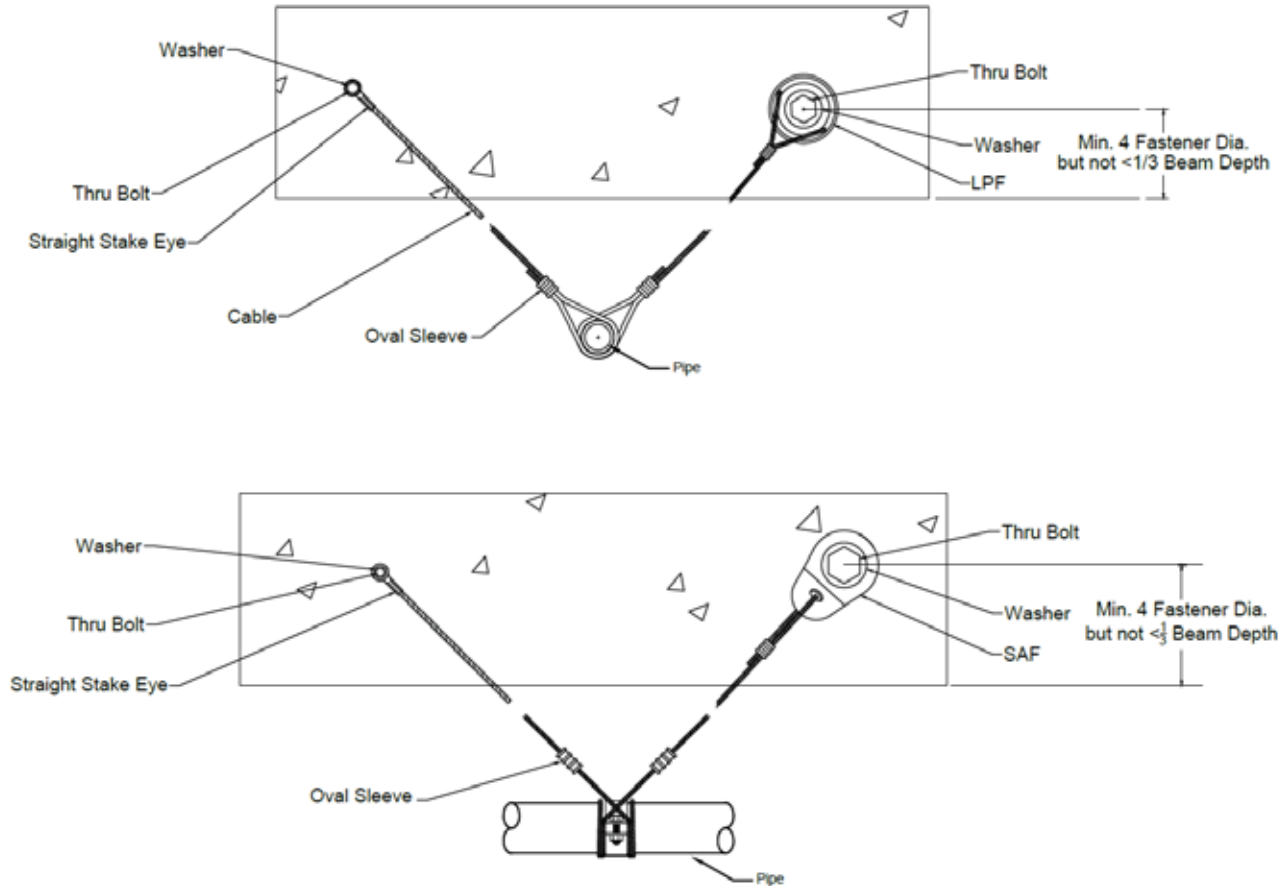

Maximum Load for Wedge Anchors in 4,000 psi (276 bar) Normal-Weight Cracked Concrete

Fastener Diameter	Fastener Min. Nom. Embedment	Min. Slab Thickness	Min. Edge Distance (in.)	LPF			SAF (All)			Stake Eye		
				30°-44°	45°-59°	60°-90°	30°-44°	45°-59°	60°-90°	30°-44°	45°-59°	60°-90°
3/8"	2.375	5	4	179 lbs.	264 lbs.	313 lbs.	157 lbs.	226 lbs.	272 lbs.	157 lbs.	226 lbs.	272 lbs.
1/2"	3.750	6	6	304 lbs.	453 lbs.	531 lbs.	255 lbs.	368 lbs.	442 lbs.	255 lbs.	368 lbs.	442 lbs.
5/8"	3.875	6	6	467 lbs.	694 lbs.	814 lbs.	392 lbs.	566 lbs.	678 lbs.	N/A	N/A	N/A
3/4"	4.500	7	8	646 lbs.	959 lbs.	1,125 lbs.	544 lbs.	786 lbs.	942 lbs.	N/A	N/A	N/A



NFPA-13 2019

Load: Parallel to Structural Member

Angles: G (30°), H (45°), and I (60°)

Material: Wedge Anchors in 6,000 PSI (414 bar) Normal Weight Cracked Concrete

Table: 18.5.12.2 (E)

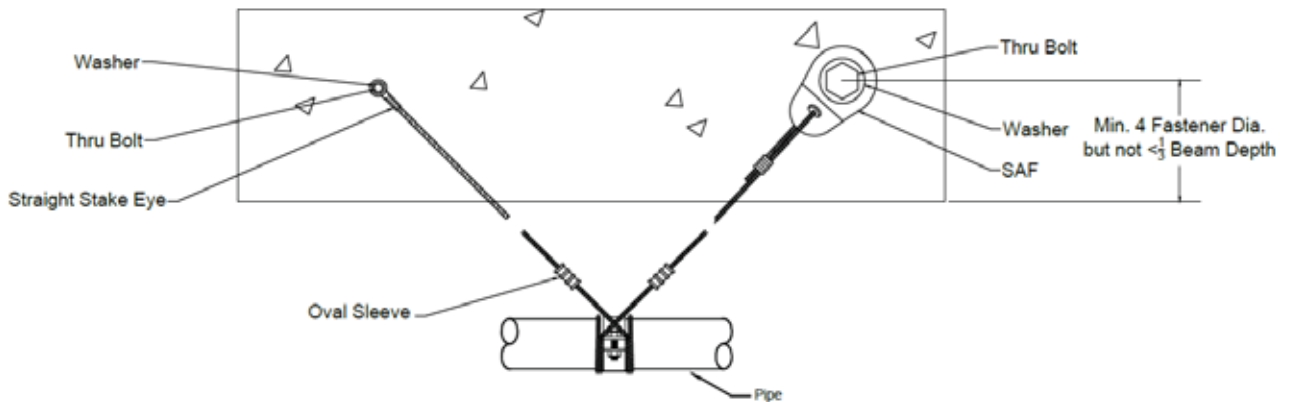
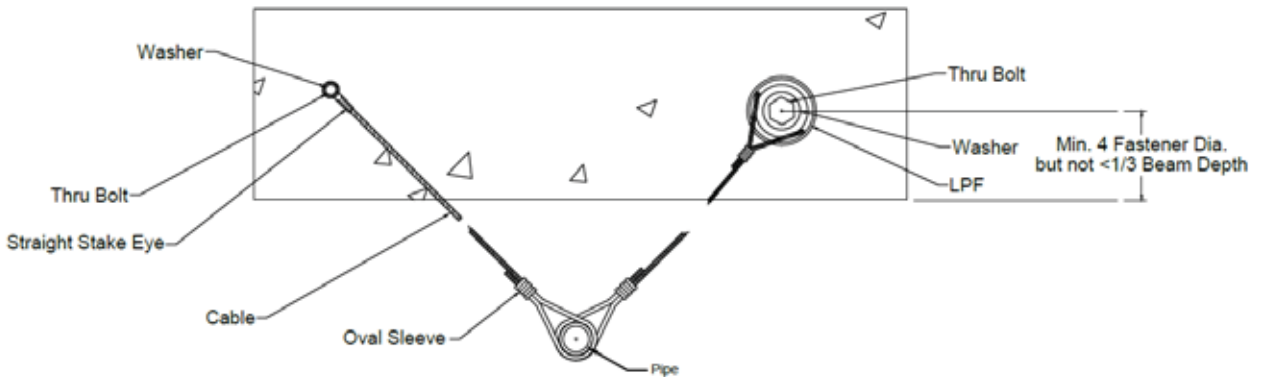

Maximum Load for Wedge Anchors in 6,000 psi (414 bar) Normal-Weight Cracked Concrete

Fastener Diameter	Fastener Min. Nom. Embedment	Min. Slab Thickness	Min. Edge Distance (in.)	LPF			SAF (All)			Stake Eye		
				30°-44°	45°-59°	60°-90°	30°-44°	45°-59°	60°-90°	30°-44°	45°-59°	60°-90°
3/8"	2.375	5	4	189 lbs.	277 lbs.	329 lbs.	167 lbs.	240 lbs.	289 lbs.	167 lbs.	240 lbs.	289 lbs.
1/2"	3.750	6	6	337 lbs.	500 lbs.	589 lbs.	287 lbs.	414 lbs.	498 lbs.	287 lbs.	414 lbs.	498 lbs.
5/8"	3.875	6	6	517 lbs.	766 lbs.	902 lbs.	441 lbs.	636 lbs.	764 lbs.	N/A	N/A	N/A
3/4"	4.500	7	8	714 lbs.	1,055 lbs.	1,243 lbs.	611 lbs.	881 lbs.	1,058 lbs.	N/A	N/A	N/A



NFPA-13 2019

INSTRUCTIONS

Load: Parallel to Structural Member

Angles: G (30°), H (45°), and I (60°)

Material: Connection to Steel Using Unfinished Steel Bolts

Table: 18.5.12.2 (K)

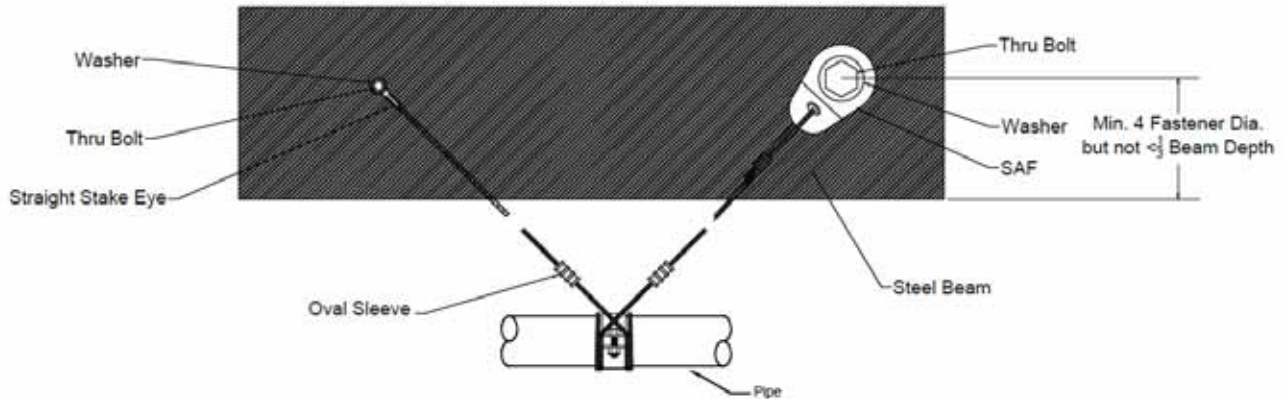
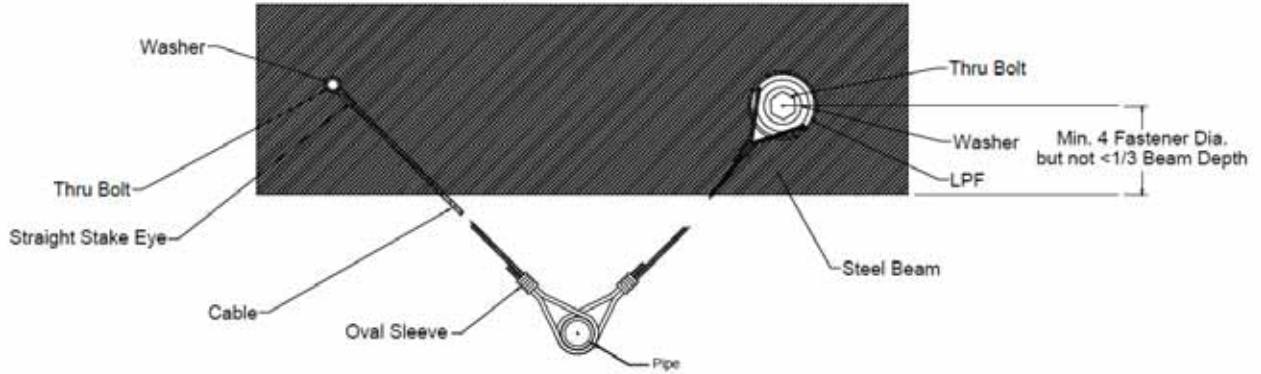

Diameter	30° - 44°	45° - 59°	60° - 90°
1/4"	325 lbs.	458 lbs.	565 lbs.
3/8"	735 lbs.	1,035 lbs.	1,278 lbs.
1/2"	1,300 lbs.	1,830 lbs.	2,260 lbs.
5/8"	2,045 lbs.	2,880 lbs.	3,557 lbs.



NFPA-13 2019

Load: Perpendicular to Structural Member

Angles: A (30°), B (45°), and C (60°)

Material: Cable looped around top member of bar joist

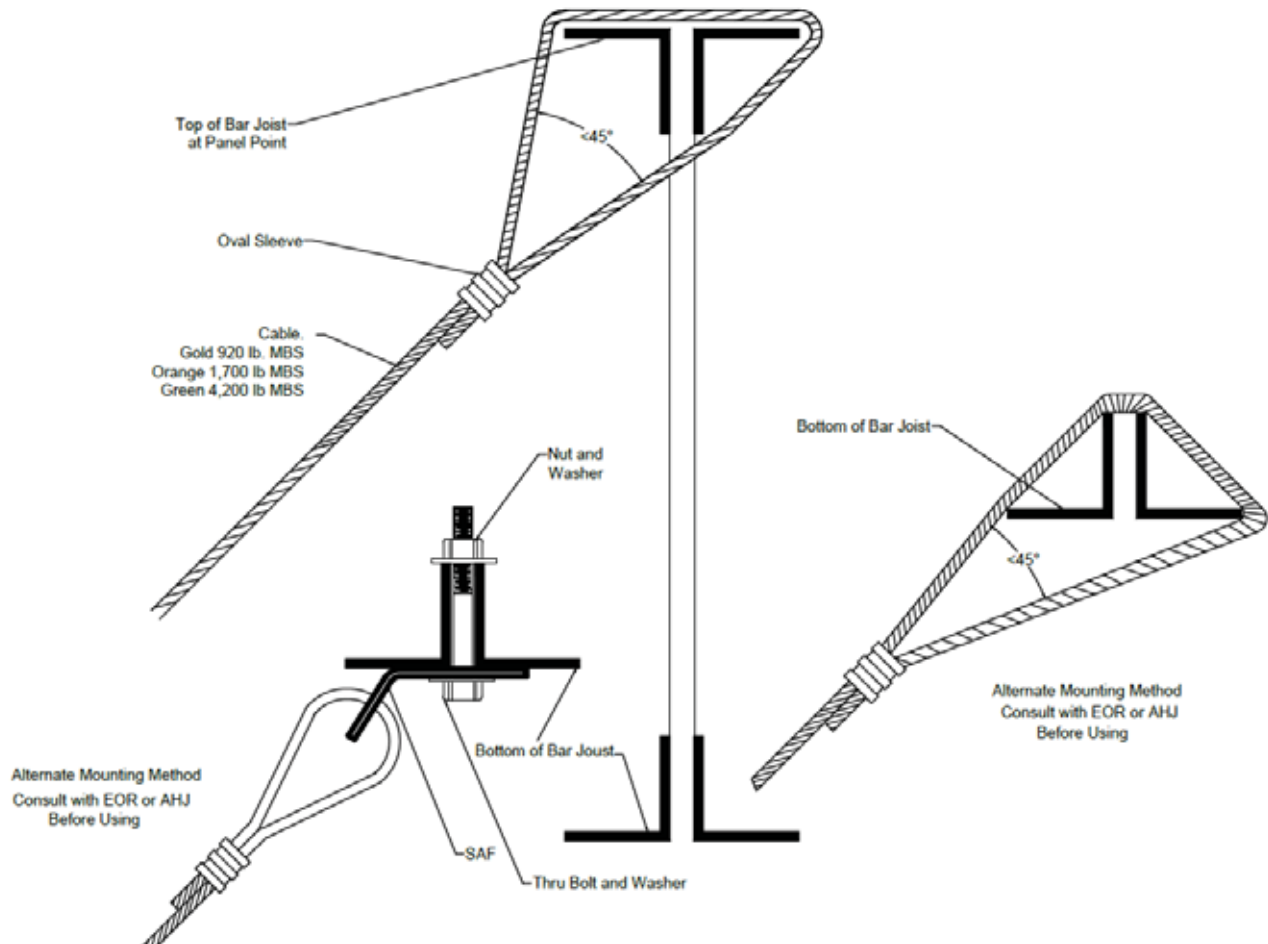

Cable Color	Working Load	30° - 44°	45° - 59°	60° - 90°
Gold	418 lbs.	209 lbs.	295 lbs.	361 lbs.
Orange	770 lbs.	385 lbs.	544 lbs.	666 lbs.
Green	1,900 lbs.	950 lbs.	1,343 lbs.	1,645 lbs.
Black	3,180 lbs.	1,590 lbs.	2,248 lbs.	2,753 lbs.



NFPA-13 2019